



CMOS **BULLETIN**

SCMO

*Canadian Meteorological
and Oceanographic Society*

*La Société canadienne de
météorologie et d'océanographie*

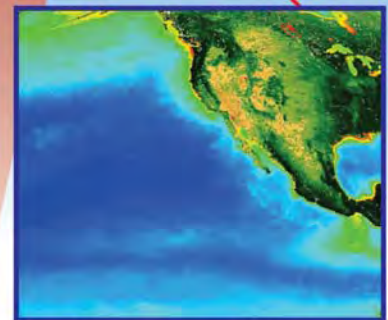
April / avril 2017

Vol. 45 No. 2

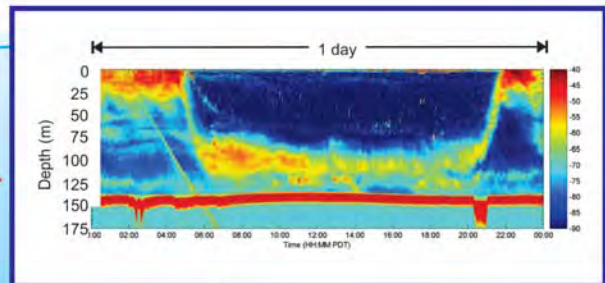
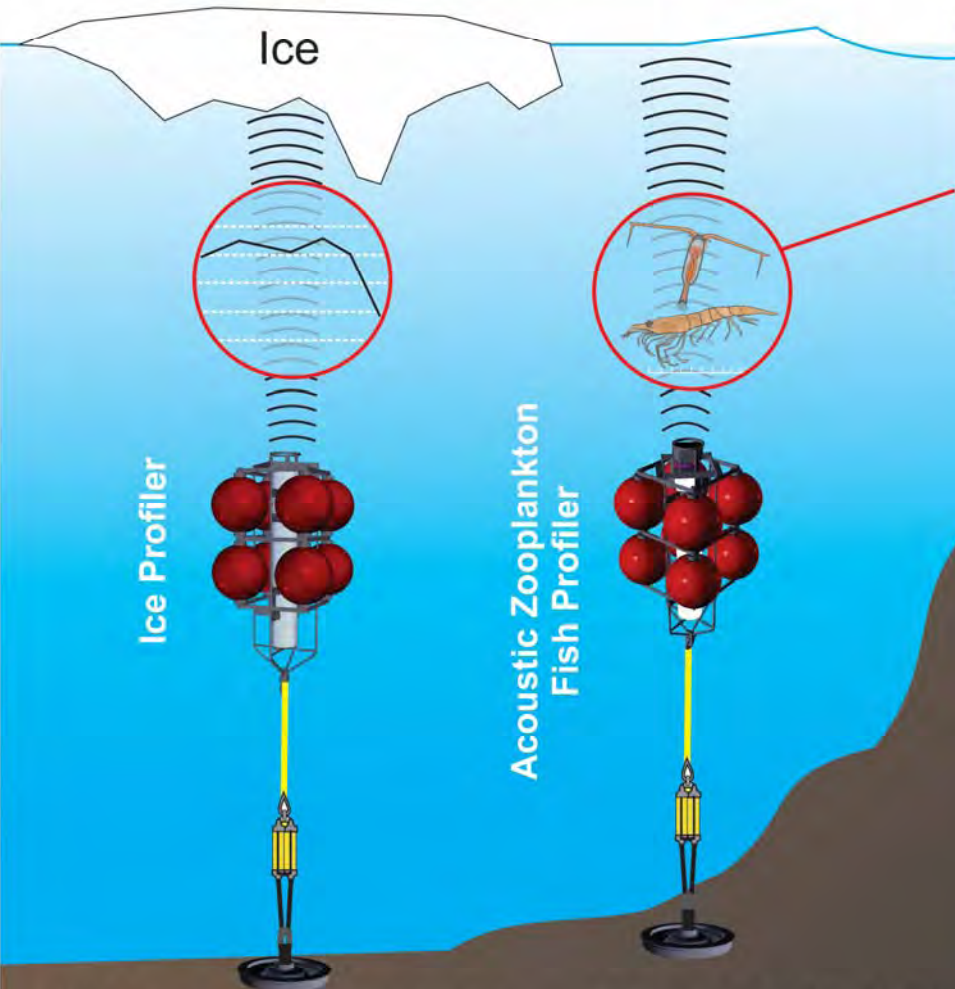


Photo: Cindy Johnson

Oceanographic specialists/
Spécialistes océanographiques



Ocean colours are chlorophyll concentrations and land colours are NDVI



ASL offers:

- Ice Profiler and SWIP
- Acoustic Zooplankton Fish Profiler
- Teledyne RD Instruments
- Teledyne Oceanscience
- Teledyne Benthos
- WERA NorthernRadar
- Airborne/Spaceborne Remote Sensing



ASL offers an extensive equipment lease pool

ASL Environmental Sciences Inc.
#1-6703 Rajpur Place
Victoria, British Columbia
V8M 1Z5 Canada

Toll-free: 1-877-656-0177
Fax: +1 250 656-2162
email: aslenv@aslenv.com
website: www.aslenv.com

CMOS Bulletin SCMO
Volume 45 No. 2.
April 2017 - avril 2017

| | |
|--|----|
| Cover Page / Page couverture | 2 |
| Words from the President / Mot du président Martin Taillefer | 3 |
| Articles and Reports | |
| Article: The Nipher Rain Gauge, by Kenneth A. Devine | 5 |
| Article: Dawning of a New Country and a New Weather Service, by David Phillips | 7 |
| Article: Selected Weather Events in 1867, by David Phillips | 9 |
| Special 50th Anniversary Interviews: | |
| Lucie Vincent | 12 |
| Xuebin Zhang | 14 |
| Nigel Roulet | 16 |
| Report: Seasonal Outlook for Spring 2017, by M. Markovic, B. Merryfield, B. Denis, M. Alarie | 19 |
| CMOS Business and News | |
| CMOS Congress News | 21 |
| 50th Anniversary: Birth of the CMOS Logo, by Robert Jones | 22 |
| 50th Anniversary: Formation of the CMS, by Robert Jones | 23 |
| 50th Anniversary: Historical Highlights, by Richard Asselin | 24 |
| 50th Anniversary: Golden Jubilee Fund | 25 |
| Book Review: A Farewell to Ice | 26 |
| Book Review: A Canadian Environmental Chronicle (1954-2015) | 27 |
| Revue de littérature: Stochastic Analysis of Scaling Time Series | 29 |
| In Memoriam: Matthew J. Parker | 30 |
| Other CMOS News | 31 |

CMOS Bulletin SCMO

"at the service of its members / au service de ses membres"

Editor / Rédactrice: Sarah Knight

Director of Publications /

Directeur des publications: Douw Steyn

Canadian Meteorological and Oceanographic Society / Société canadienne de météorologie et d'océanographie

E-mail: bulletin@cmos.ca;

Courriel: bulletin@scmo.ca

CMOS Office / Bureau de la SCMO

P.O. Box 3211, Station D

Ottawa, Ontario, Canada, K1P 6H7

Homepage: <http://www.cmos.ca>

Page d'accueil: <http://www.scmo.ca>

Gordon Griffith, Ing., P. Eng., FEC

Executive Director - Directeur général

Tel/Tél.: 613-990-0300

E-mail/Courriel: cmos@cmos.ca

Ms. Qing Liao

Office Manager - Chef de bureau

Tel/Tél.: 613-990-0196

E-mail/Courriel: accounts@cmos.ca

CMOS Accredited Consultant

Experts-Conseil accrédité de la SCMO

Douw G. Steyn

Air Pollution Meteorology

Boundary Layer & Meso-Scale Meteorology

4064 West 19th Avenue Vancouver,

British Columbia

V6S 1E3 Canada

Tel: 604-827-5517; Home: 604-222-1266

Email: dsteyn@eos.ubc.

CMOS exists for the advancement of meteorology and oceanography in Canada.

Le but de la SCMO est de promouvoir l'avancement de la météorologie et l'océanographie au Canada.

Cover Page / Page couverture

This photo was taken using an iPad with an external macro lense attached. It was snowing that day, but despite my state of rush I noticed the perfection and detail in each snowflake softly falling. I parked my car and began to photograph the snowflakes as they landed on my windshield. When I entered my workplace, I was mesmerized by the texture and intricate lines in the frost that had formed on my studio window. The artist in me wanted to explore the contrasts of the random textures of the frost with the divine patterns within the crystal formations. Many of the patterns resembled a palm leaf, another contrast to the bitter cold that day.

-Cindy Johnson, Artist and Goldsmith (www.rfj.ca)

The Art and Science of Ice. The water molecule is very special and essential to life. There is so much to understand... way beyond me and a single paragraph. Turning water into ice can be even more of a mystery. The ice art on the window panes also holds a lot of science.

The ice art revealed on the freezing glass originates from water vapour sublimating onto the crystals. They flourish in the same fashion as snowflakes. Their growth may be primarily determined by the temperature and humidity of the air but is also influenced by environmental factors like the sun, wind and even condensation ice nuclei and grime on the glass. The temperature of the glass is also an important issue and now with double glazed and even triple glazed windows, ice art is no longer as common as it once was with the single sheet of glass.

The purest, largest and most symmetrical ice crystals form when the environmental factors are removed. Plein air art out in the elements include these environmental influences and that is when some of the most interesting ice art can be created. Water vapour drifting with the breeze and contacting freezing glass can add to flowers or ferns of ice in the direction of the wind. The beautiful patterns as photographed by Cindy Johnson are the just tip of the ice berg – so to speak.

-Phil Chadwick, Artist and Meteorologist (<http://philtheforecaster.blogspot.ca/>)

Cette photo a été prise à l'aide d'un iPad muni d'un objectif macro externe. Il neigeait ce jour-là et j'ai remarqué, malgré mon impatience, la perfection et le détail de chaque flocon qui tombait doucement. J'ai garé ma voiture et photographié les flocons qui s'accumulaient sur le pare-brise. Arrivée au travail, j'ai été hypnotisée par le jardin de givre qui ornait la fenêtre de mon studio. L'artiste en moi a tout de suite voulu explorer les contrastes de la texture aléatoire du givre et les motifs sublimes qu'avaient peints les cristaux : des feuilles de palmiers, qui contrastaient avec le froid mordant!

-Cindy Johnson, artiste et orfèvre (www.rfj.ca)

L'art et la science de la glace. La molécule d'eau est très particulière et essentielle à la vie. Il y a tant à comprendre... bien au-delà de ma contribution et d'un seul paragraphe. La transformation de l'eau en glace s'avère un mystère plus grand encore. L'œuvre de glace sur la fenêtre recèle en outre toute une science.

Le jardin de givre qui apparaît sur la fenêtre refroidie est le fruit de la vapeur d'eau se sublimant sur les cristaux. Le tout se façonne à la manière des flocons de neige. La température de l'air et l'humidité déterminent principalement la croissance du motif. Des facteurs environnementaux comme le soleil, le vent et même les noyaux de condensation et les saletés sur la vitre jouent néanmoins un rôle. La température du verre importe aussi. De nos jours, les fenêtres à double ou même à triple vitrage réduisent l'occurrence de telles œuvres, jadis fréquentes.

Les cristaux de glace les plus purs, les plus gros et les plus symétriques se forment en l'absence de ces facteurs environnementaux. L'art en plein air, soumis aux éléments, profite de ces influences environnementales. C'est d'ailleurs grâce à ces conditions que se créent les œuvres de glace les plus fascinantes. La vapeur d'eau qui suit la brise et entre en contact avec le verre sous zéro s'arrime aux fleurs ou aux fougères de glace selon la direction du vent. L'élégante végétation qu'a photographiée Cindy Johnson ne représente qu'un pan de ce jardin secret.

-Phil Chadwick, artiste et météorologue (<http://philtheforecaster.blogspot.ca/>)



Words from the President



Dear Friends and Colleagues –

It is with great sadness that the Canadian Meteorological and Oceanographic Society (CMOS) received the news of the passing of the President of the American Meteorological Society (AMS) Matthew J. Parker, CCM, who died in his sleep on the night of March 15th, 2017.

The passing of Matt Parker is a huge loss for science. He was a dedicated meteorologist, who championed for positive change on so many levels of atmospheric science research, education and communication. As scientific communities across the world reflect on our loss, may it also be a time for taking note of all that Matt accomplished and planned for the future, and use his passion and commitment as an example for us all. Perhaps this is a time for our governments to take

heed of the urgency of the research that our members conduct, and of the importance of the support platforms that national scientific societies like the AMS and CMOS provide. With the ever-increasing number of climate change indicators being observed and recorded at unprecedented levels, we no longer have the luxury of time to continue debating the value of atmospheric, climate and oceanic research. I strongly believe that now, more than ever, this research needs the support that CMOS can provide, as we work to seed ideas, take action, share our findings, and strive for positive change in our environment.

As CMOS approaches its 51st annual congress, making this society no spring chicken, the AMS recently held their 97th. Since the early days of a meteorological society in Canada, when the formal announcement of the foundation of the Canadian Branch of the Royal Meteorological Society (RMetS) was made in 1939 at a joint meeting of the AMS and RMetS, the AMS has served as a model, with its executive and members acting a constant source of support, inspiration and collaboration. In 2012 CMOS and the AMS signed a Memorandum of Understanding (MOU) of mutual benefit, under the leadership of then-Presidents Dr. Harinder Ahluwalia of CMOS and Dr. William Gail of the AMS. An important milestone.

“In 2014, CMOS and the AMS came together at the first World Weather Open Science Conference conducted by the World Meteorological Organization (WMO) to review the state-of-the-art technologies and map out the scientific frontiers for the next decade. The focus was on enhancing collaboration across the weather enterprise (public, private and research sectors) to benefit societies worldwide. Following on from this, CMOS and the AMS produced a White Paper summarizing panel discussions and recommendations for the next steps” [Report of the Three Special Panels at WWOSC 2014 on Creating a “Global weather and climate ready society” White Paper]

At a time when the impacts of weather and climate are growing dramatically, the interactions among research scientists across the country, and around the globe, are increasingly important. As we reflect and mourn the loss of AMS President Matt Parker, we must not divert our attention for too long from continuing this important work that all of us do at CMOS and the AMS.

From our Society to yours, I personally would like to thank Matt Parker, for being a beacon of commitment, passion, intellect, and vision, in these challenging and changing times.

Fair winds and a following Sea,

M.L. Taillefer, President



Chers amis et collègues,

La Société canadienne de météorologie et d'océanographie a appris avec tristesse le décès du président de l'American Meteorological Society (AMS), Matthew J. Parker, CCM, qui s'est éteint dans son sommeil dans la nuit du 15 mars 2017.

Son décès représente une énorme perte pour la science. Météorologiste dévoué, Matt a défendu la mise en œuvre de changements positifs relativement à plusieurs aspects de la recherche, de l'éducation et de la communication liées aux sciences atmosphériques. Tandis que les communautés scientifiques d'ici et d'ailleurs déplorent cette perte, prenons le temps de nous remémorer les accomplissements et les projets de Matt. Et prenons en exemple sa passion et son engagement. Il est peut-être temps pour nos gouvernements de se rendre compte de l'urgence des travaux que produisent nos membres et de l'importance du soutien qu'apportent les sociétés scientifiques nationales comme l'AMS et la SCMO. Étant donné le nombre toujours croissant d'indicateurs de changements climatiques que l'on observe à des niveaux sans précédent et que l'on consigne, nous n'avons plus le luxe de débattre à l'infini de la valeur de la recherche sur l'atmosphère, le climat et les océans. Je crois fermement, maintenant plus que jamais, que cette recherche nécessite le soutien que la SCMO peut lui fournir, tandis que nous faisons germer des idées, passons à l'action, partageons nos découvertes et visons une évolution positive de notre environnement.

La SCMO se dirige vers son 51^e congrès annuel, prouvant qu'elle n'est pas née de la dernière pluie, tandis que l'AMS, elle, a tenu son 97^e congrès. L'AMS nous a servi de modèle depuis les balbutiements d'une société de météorologie au Canada, lors de l'annonce officielle de la création de la section canadienne de la Royal Meteorological Society (RMS) en 1939 au cours d'une rencontre conjointe de l'AMS et de la RMS. En outre, tant le conseil d'administration de l'AMS que ses membres ont constitué une source constante de soutien, d'inspiration et de collaboration. En 2012, sous la direction des présidents de l'époque, Harinder Ahluwalia de la SCMO et William Gail de l'AMS, les deux sociétés ont signé une entente menant à des bénéfices mutuels : un jalon d'importance.

« En 2014, la SCMO et l'AMS se sont réunies à la première Conférence scientifique publique mondiale sur la météorologie, organisée par l'Organisation météorologique mondiale (OMM), afin d'examiner les technologies de pointe et d'orienter l'exploration scientifique des dix prochaines années. Il s'agissait principalement de renforcer la collaboration au sein de l'entreprise météorologique (soit les secteurs public, privé et universitaire) dans le but d'en faire profiter toutes les sociétés de la planète. À la suite de cette rencontre, la SCMO et l'AMS ont rédigé un livre blanc résumant les discussions d'experts et les recommandations pour les prochaines étapes » [Report of the Three Special Panels on Creating a "Global weather and climate ready society"].

Comme les impacts des intempéries et du climat croissent considérablement, les interactions entre les chercheurs, d'ici et d'ailleurs, s'avèrent de plus en plus importantes. Tandis que nous sommes touchés par le décès du président de l'AMS, Matt Parker, nous devons rester alertes et poursuivre les importants travaux que nous conduisons au sein de la SCMO et de l'AMS.

De notre société à la vôtre, je remercie Matt Parker d'avoir été un parangon de dévouement, de passion, d'intelligence et de vision, en ces temps d'épreuves et de changements.

Bon vent, bonne mer.

M. L. Taillefer, Président

Article: The Nipher Rain Gauge

The Nipher Rain Gauge

Kenneth A. Devine, Meteorological Instrument Consultant

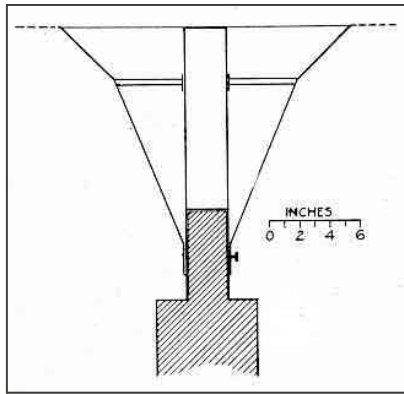


Figure 1: Nipher's Rain Gauge of 1878 (Middleton, 1969).

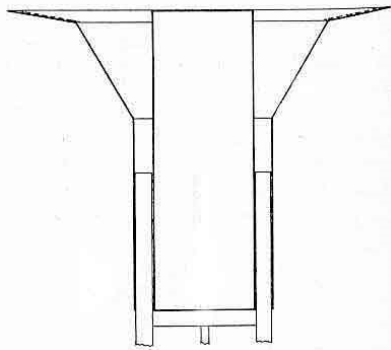


Figure 2: The Brooks Shield, 1938.



Figure 3: A similar gauge to the Brooks Shield being tested in Kapsukasing, Ont, in the 1940s.

Mekis, 2008). In general, the gauge which catches the most precipitation, thereby minimizing negative errors, is the better gauge. A later study of the aluminum shielded Canadian Nipher snow gauge at Swift Current from 1961 to 1965 reported that it was -2.9% wrt the 3.6" copper gauge from 137 rainfall days (Pelton, 1965). For 76 days with rainfalls of 2.3 mm or less at Swift Current, the Nipher reported -13.9% wrt the standard copper gauge. A reanalysis of the 1999 to 2005 data for 158 rain days at Egbert, Ontario indicated that the fiberglass shielded Nipher reported -7.4% wrt the pit gauge but -18.2% for those 100 days with less than three millimeters of rainfall. Thus while the Nipher reports similar rainfall values to the older copper manual gauge, for very light rainfalls it has a large negative error. From the Egbert data there was a loss of 0.15 mm per measurement which is mostly due to the retention errors of the large, 52 cm high, copper receiver used in the Nipher (Goodison & Louie, 1985). The evaporative and splash errors have previously been documented (Devine & Mekis, 2008).

While the "Nipher" used in the Canadian service is classified as a snow gauge, it was originally designed in the nineteenth century as a rain gauge (Abbe, 1888).

In 1769 William Heberden found that an unshielded rain gauge caught less rainfall as it was raised (Heberden, 1769). This was due to the general increase in wind with height. An unshielded receiver will have an additional increase in wind speed over the gauge orifice due to air from below being forced over the top of the orifice. This increase in wind speed would cause some of the rain drops to be deflected away from the receiver orifice. Hence, the rainfall caught by the gauge would be less than the actual rainfall. In 1878, F.E. Nipher developed a rain gauge that was shielded so that the air flow below the orifice top was directed downward (Figure 1), making the gauge height independent. The original Nipher included a receiver surrounded by three interconnected cones that acted as a wind shield.

Snowfall is more affected by this wind increase over the receiver orifice than is rainfall. Beginning in the USA this same Nipher shield was applied to a receiver in order to measure snowfall (Figure 2). The original Nipher had the lowest conic section narrowed down to the same diameter as the receiver. The shield would have filled with snow rendering it useless. Brooks opened up the lower end to allow the snow to fall free of the shield. A shielded gauge which appears similar to Brooks' was field tested in Canada during WWII (Figure 3; Toronto Register No. 300).

Further developments by the National Research Council under the direction of Bill Middleton, head (until 1946) of the Instrument Section of Meteorological Service of Canada (MSC), led to a manual snow gauge with an exponentially shaped horn to replace Nipher's conic sections – a design that was uniquely Canadian (Figure 4).

During WWII Bill Middleton and his staff tested a 5" snow gauge similar to the Brooks gauge. Middleton likely also incorporated the curved shield design from M.S. Bastamoff (Bastamoff, 1932 and Abbe, 1888). Eventually a number of tiny models of different types of snow shields were constructed. These were tested in a small wind tunnel at the National Research Council (NRC) in Ottawa, from which the shield with the elliptical curve was selected (Macartney, 1945). The shields, which went into service circa 1953, were made from solid aluminum spun into a flare which was 24" (61 cm) wide at the top (MSC, 1953). During the development of fiberglass Nipher shields for 8" weighing gauges in 1985, a smaller one for the manual 5" gauge was also designed, since the fiberglass units were one third the cost of the aluminum shields (Metcalf & Goodison, 1985). At that time the curve of the shield was changed from elliptical to spherical with no change in collection efficiency.

For 172 daily rainfall events between 1943 and 1945, this 5" Nipher/Brooks snow gauge reported volumes 0.24% higher than the 3.6" standard copper rain gauge (Toronto Register No. 300). But it should be noted that the 3.6" copper gauge measured -5.2% with-respect-to (wrt) a World Meteorological standard pit gauge during a six year rain gauge comparison at Egbert, Ontario (Devine &

Article: The Nipher Rain Gauge

While primarily used as a snow gauge in Canada, the Nipher still collects the increasingly frequent winter rainfalls. The Nipher acts as a precipitation gauge throughout the year, whereas the gauges designed only for rainfall such as the Type B manual gauge and TB3 tipping bucket are taken out of service for most of the winter.

The present Canadian 5" Nipher snow gauge has proven to be the best system for snowfall measurements in the world next to the Double Fence International Reference (Goodison et al, 1998), and superior to the Tretyakoff shielded gauges used in northern Europe (Strangeways, 2007). This report documents the operational accuracy for rainfall. Since manual gauges remain the best method for determining total rainfall or snowfall, locating Nipher gauges at manned climate stations would be worthwhile since the present snow depths are not an accurate method for measuring snowfall. The Nipher also has the highest precipitation capacities, next to the storage gauges, which may be useful in coastal areas with high rainfall. Both the advantages and shortfalls of the Nipher gauges for rainfall have been shown, and this gauge remains an important source for accurate precipitation measurements in Canada (AES, 1985).

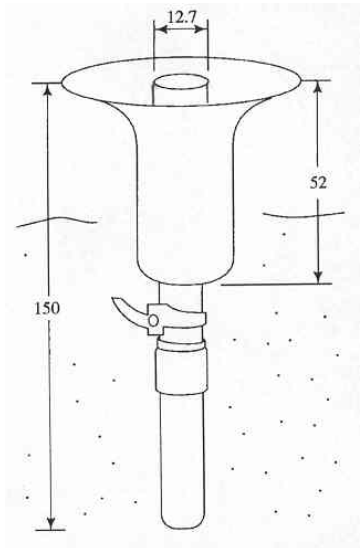


Figure 4: The Canadian Nipher Snow Gauge, with dimensions in centimeters.

“Let us hope that, in time, it will be realized that an accurate knowledge of the amount of rain or snow which falls on a country is as important as many other statistical activities of government.” (Middleton, 1941)

References:

- Abbe, C., 1888. *Meteorological Apparatus and Methods*, Government Printing Office, Washington.
- AES, 1985. *Measuring Snowfall Water Equivalent using the Nipher Shielded Snow Gauge System*, IB 04-03-01/1, Toronto, October 30 1985.
- Bastamoff, M.S., 1932. *Sur les pluviometers*, La Meteorologie, Vol.8.
- Brooks, C.F., 1938. *Need for Universal Standards for Measuring Precipitation, Snowfall, and Snowcover*, International Association of Hydrology, Bulletin 23, Riga.
- Devine, K.A. and É. Mekis, 2008. *Field accuracy of Canadian rain measurements*. Atmosphere-Ocean 46 (2), 213–227.
- Goodison, B.E., Louie, P.Y.T., 1985. *Canadian Methods for Precipitation Measurement and Correction*, WMO Workshop on the Correction of Precipitation Measurements, Zurich, April 1985.
- Goodison, B.E., Louie, P.Y.T., Lang, D., 1998. *WMO Solid Precipitation Measurement Intercomparison*, WMO Instruments and Observing Methods Report No.67, WMO/TD-No.872. Geneva.
- Heberden, W., 1769. *Of the different quantities of rain, which appear to fall at different heights, over the same ground*, Philosophical Transactions of the Royal Society, 59: 359-362.
- Macartney, L.E., 1945. *Wind Tunnel Investigation of Airflow over Snow Gauges*, National Research Council of Canada, Report No.MA-168, Ottawa, November 1945.
- Metcalfe, J.R., Goodison, B.E., 1985. *Fiberglass vs Aluminum Nipher Shield – Field Test*, Report of the Canadian Climate Centre, AES, Toronto, October 24 1985.
- Meteorological Service of Canada (MSC), 1953. *Snow Gauges*, Instrument Circular 54, MSC Circular 2360.
- Middleton, W.E. Knowles, 1941. *Meteorological Instruments*, University of Toronto Press, Toronto.
- Middleton, W.E. Knowles, 1969. *Invention of the Meteorological Instruments*, John Hopkins Press, Baltimore.
- Nipher, F.E., 1878. *On the Determination of the True Rainfall in Elevated Gauges*, American Association for the Advancement of Science, Vol.27.
- Pelton, W.L., 1965. *A Comparison of Three Types of Rain Gauges*, Can. J. Plant Sci., Vol.45.
- Strangeways, I., 2007. *Precipitation: Theory, Measurement and Distribution*, Cambridge University Press, New York.
- Toronto Register No. 300, 1946. Climate Archive, Downsview.



About Ken

Ken began his career as an observer and Officer-in-Charge at remote upper air stations. Later he worked three years as a senior electronics technician which included installing the first operational weather stations in Canada. After obtaining his degree and completing the meteorologist training in 1971, he spent four years forecasting on the east coast before moving to headquarters. In Toronto he worked in instrument development, project management, Field Services and finally as Superintendent of Climate Standards. After retiring in 1998 he has been researching and writing articles on the history of meteorological instruments in Canada.

Article: Weather on Canada's First Day

Dawning of a New Country and a New Weather Service

David Phillips, Senior Climatologist, Environment and Climate Change Canada

The sun dawned across Canada on the first day of nationhood back on the first of July, A.D. 1867. There were a few sprinkles of rain here and there in Ontario, but across Nova Scotia, New Brunswick, and the Canadas (Quebec and most of Ontario), Confederation Day was warm, sunny and uneventful – what some described as boring weather. Afternoon highs across the new nation were seasonably warm reaching a high of 33°C in Hamilton and Windsor, ON. The absence of summer thunderstorms and high humidity was a rarity of sorts for July. Everywhere, Canadians rejoiced at the alliance of the two Maritime states with the two Canada provinces into the British North American Union. Owing to agreeable weather – “a finer day could not have been desired” – Canadians spent the holiday Monday outdoors amongst family, friends and strangers celebrating the historic moment and enjoying picnic lunches, parades, sports and games. First-day Canadians – three million of us – were pleased to have an extra day off. In large cities and towns from Sarnia to Sherbrooke, and Sussex to Sydney, officials in market squares, parks and on the steps of public buildings read aloud the Queen’s Official Proclamation creating the Dominion of Canada.

In several communities across the Dominion, shortly after midnight on the first day of July, the pealing of church bells and the dull thudding of multiple-gun salutes woke people. Once the official business was over, citizens turned to watching harness races, cricket matches, sailing and sculling events, and canoe and tub races. Where there were no brass bands, racing tracks or regattas, farming families gathered at fairgrounds and picnic spots. Everywhere crowds marched in different directions, singing loyal and patriotic anthems. In several places, the festive day ended with a spectacular display of fireworks late into the evening.

No one knew what the weather was going to be on that first day. In Sarnia, ON, a local newspaper reported that: “Whether caused by the hot weather, or bad whiskey, or both combined, fighting seems to have been the rage wherever a number of people were gathered together. It is to be regretted that the first day of our national existence should be marked by so much disreputable conduct.” In Barrie, ON, celebrations verged on the hilarious as contestants scaled a 10-m greasy pole or quick-stepped on rolling poles, frantically trying not to slip into the waters of Lake Simcoe. In Toronto, trees were decorated with hundreds of festive Chinese paper lanterns. Children waved Union Jacks and an ox was roasted in front of St. Lawrence Hall. In the afternoon, thousands enjoyed a picnic on government grounds. In the evening, hundreds danced away and, after 9 PM, fireworks were set off in Queen’s Park. In Montreal, QC, the sky was clear and the day was comfortable with a refreshing breeze. Enormous crowds filled picnic and sports grounds, played games, listened to brass bands, and watched the spectacular display of fireworks late at night. Adding to the dazzle, an intensely brilliant meteor shot through the sky at 11:30 PM leaving a long trail of multi-colours that remained in view for several minutes. At Fredericton, NB, gusty winds hampered accuracy during a shooting match involving 40 competitors. The local newspaper reported: “It was the dullest holiday that could be imagined, so dull that even a dog fight would have been hailed with delight.” In Halifax, NS, a volunteer artillery fired their guns and were answered by the naval brigade on the Dartmouth side of the harbour.

METEOROLOGICAL SERVICE OF THE DOMINION OF CANADA

WEATHER BULLETIN

ISSUED BY THE CENTRAL OFFICE, Toronto, AT 10:00 A.M. July 1st, 1867

PROBABILITIES FOR THE NEXT 24 HOURS

FOR THE FAR WEST:-
Light winds; clear to fair weather; high temperatures

FOR THE WEST:-
Light westerly to southerly winds; clear; stationary temperatures

FOR THE UPPER LAKE REGION:-
Increasing southerly winds; fair to cloudy; showers; rising temperatures

FOR THE LOWER LAKE REGION:-
Increasing southerly winds; clear weather; stationary to rising temperature

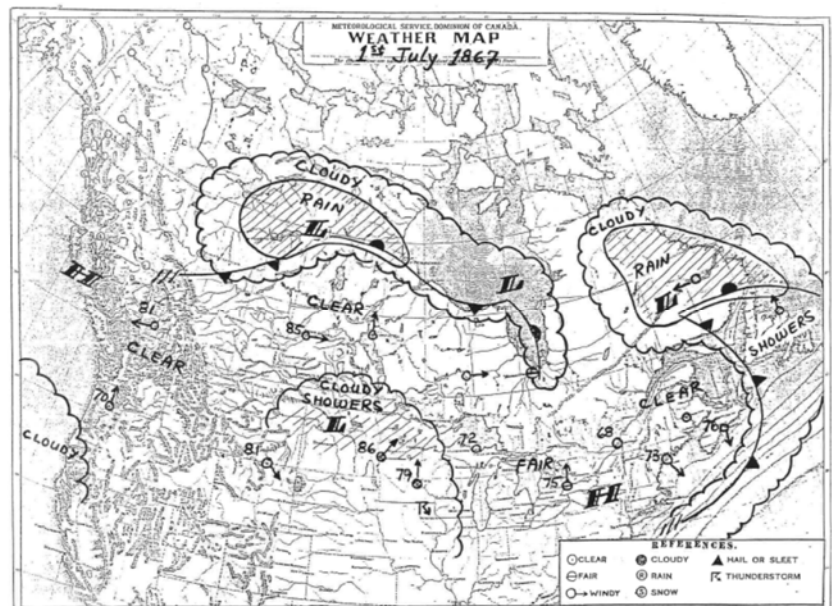
FOR THE ST. LAWRENCE:-
Decreasing northerly winds; clear weather; rising temperatures

FOR THE MARITIMES:-
Fresh southerly giving way to moderate northerly winds; rain and showers at first, then clearing and colder weather

These probabilities are issued at 10 a.m. Toronto time, and for the 24 hours following.

The ordering up of the Cautionary Storm Signals (which constitutes a storm warning), is intended to warn those connected with shipping that a storm will probably occur, either at the place at which the signal is displayed, or within such a distance that ships leaving port might be affected by it.

* A re-created weather bulletin as might have been issued by the Meteorological Service on July 1st, 1867, for more populated areas of Canada.



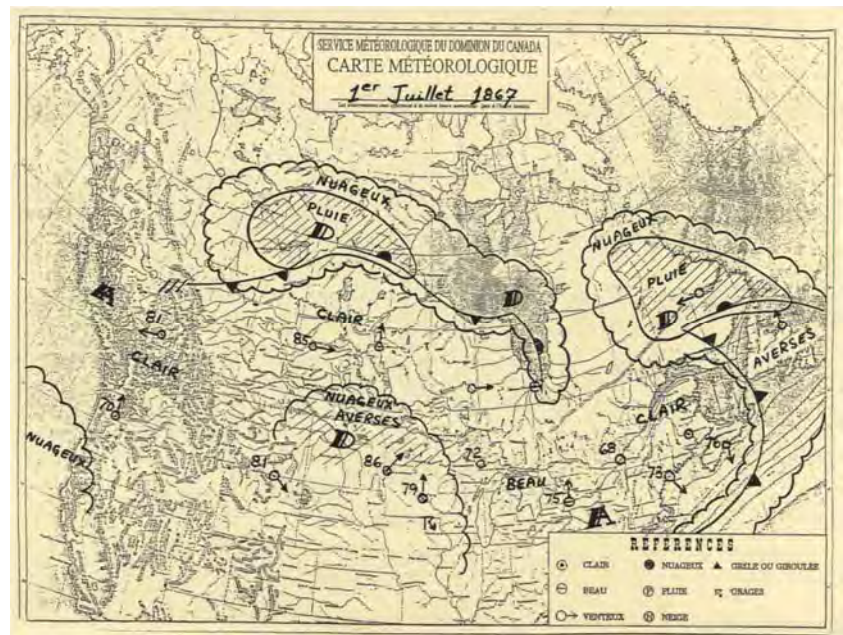
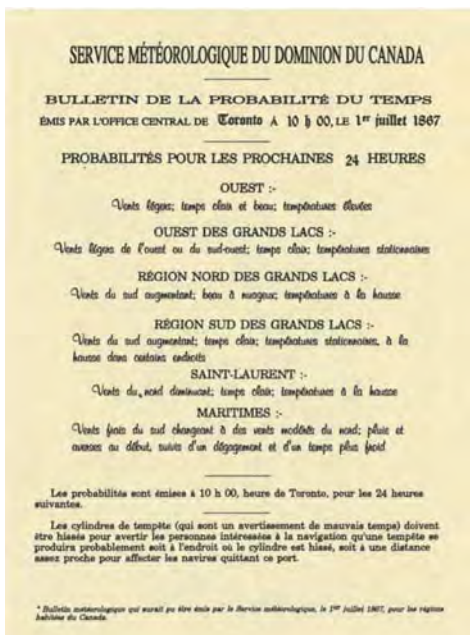
Article: Weather on Canada's First Day

Optimism prevailed across the nation as citizens spoke glowingly of Canada's many attributes. Even the weather was praised. The *Globe (and Mail)* said there was no other country in the world where the climate conditions were more favourable for health and longevity, especially in Upper Canada where the extremes of heat and cold were moderated by the Great Lakes. Official propaganda tried to let on that Canadian weather – especially winters – wasn't all that tough. In the formative years, the weather boasting was said to be "pure purple prose". Some officials convinced themselves that the bracing and cleansing cold made us superior human beings and kept out undesirables. Government officials devoted considerable attention to trying to dispel ugly rumours that Canada was a blizzard-swept desert, a frigid, useless wasteland fit only for hunters and trappers. The government even dictated that the word "cold" be avoided in all government publications, replaced instead by "buoyant or invigorating."

In 1867, Canadians had to be their own weather forecasters. Skywatching was a daily occurrence by those whose lives and livelihoods depended on coming storms. Farmers watched the shape and texture of clouds and sky colour to know when to sow and reap. Mariners listened to the wind and watched wave motions for signs of change. Early Canadians divined their personal weather forecast based on local conditions and accumulated weatherlore – such as "red sky at night, sailors' delight."

It would be almost five years after Confederation before an act of Parliament would create a national weather service and 10 years before release of the first weather forecast, although weather observing had been going on for several years. In the 1860s and 70s, a great number of ship disasters occurred on the Great Lakes and on the Atlantic Seaboard. Two years after Confederation, there were 1,914 shipwrecks on the Great Lakes alone. Increasingly, governments saw it as their duty to establish a storm-warning service. Ten years before Confederation, University of Toronto professor of meteorology and director of the Toronto Observatory, George Kingston, drafted a simple plan for storm warnings – specific telegraph operators in towns and cities would advise the city's main telegraph office immediately at the local onset of a gale. In turn, the weather office would be in direct telegraphic contact with the stations reporting the storm. Meteorologists would maintain a watch on the storm and would be able to send notice to the towns and ports likely to be affected, the probable time of its arrival, the direction expected, and its possible duration. Kingston's plan was similar to that instituted a few years later in England and in the USA a dozen years later.

In 1871, Parliament voted the grand sum of \$5,000 to establish a national weather service. But a fierce storm in 1873 was the turning point in the establishment of weather forecasting in Canada. A hurricane smashed headlong into Cape Breton's east coast – the Great Nova Scotia Cyclone laid waste a large swath of the province – almost 1,000 people died, some 1,200 ships sank or smashed and 100s of homes were destroyed. Tragically, weather officials in Toronto knew a day in advance that the hurricane would make landfall in the Maritimes, but no alarm was raised because the telegraph lines to Halifax were down. In Ottawa, politicians, prompted by the public outcry over the disaster, voted \$37,000 for the development of a national weather warning system. For five years, teenagers practiced drawing maps and making weather forecasts and warnings. From the collection of maps and rudimentary understanding of meteorological processes they were ready to issue their first public weather forecast in October of 1876.



Article: Weather in Canada's First Year

Selected Weather Events in 1867

David Phillips, Senior Climatologist, Environment and Climate Change Canada

January 16: The Moira River in Belleville, ON, rose nearly 2 m, flooding both sides of Front Street. The water flowed through the front door of many dwellings, forcing occupants to escape to the second storey. Waters flowed under an ice wedge at the mouth of the river, where, for want of a dredge, it was firmly blocked by sawdust accumulating in the harbour.

January 23: Across Prince Edward Island, snowbanks were so tall that shopkeepers didn't open their doors, and the few women who ventured out got stuck in the snow and needed help. Mail was interrupted for a week. Dogs resembled moving snowballs. When a passerby poked something dark sticking out of the snow with his shillelagh, it growled. Some citizens called for a tunnel to the mainland.

January 30: At Fort Chimo, QC, a Hudson's Bay Company Factor recorded; "The river frozen over at last and well it might with the thermometer 42°F below zero this morning. Men hauling home fire wood all got frost bitten."

February 8: A drenching rainstorm combined with fast-melting snow raised streams to flood stage in southern New Brunswick. The strong current pushed small buildings off their foundations and destroyed several bridges, including the suspension bridge at Norton. Two days later, temperatures plunged more than 20 degrees, encasing roads and rail lines in ice.

February 18: A week-long thaw and heavy rains caused ice-clogging flooding on the Grand River in Ontario. Waters filled most of the cellars in lower Perth East, ON, overflowing the Agricultural Society's grounds and threatening local mills and machine shops on the flats. Ice coming down Smith Creek grazed the street bridge.

April 8: From the *Ottawa Times*: "In Montréal [QC] some excitement was created by several sleighs crossing the ice from St. Lambert's. The ice is in a very rotten state, and the feat was rather 'fool-hardy.' Nevertheless, it succeeded. A large crowd lined the wharves, to witness the performance."

April 10: Following several fine-weather days, Ottawa, ON, streets began to dry up, enabling workers to clean the crossings. The good weather in the nation's capital tempted many ladies "to air a large quantity of dry goods on the streets ... a number of very fine specimens of dress and fancy articles had suffered greatly from mud. The more cautious did not attempt the crossings at all."

June 7: A terrific rain and hail storm and possible tornado burst over Garafraxa, ON, causing immense property losses. A tornado destroyed fences and snapped trees at Belwood. Rain fell in torrents while small creeks swept away fences and culverts, snapping trees off like "pipe stems." In an hour, the Irvine and Grand rivers rose a metre in one hour to the spring flood mark. The current carried tubs, sheep, pigs, and a horse down the stream.

June 16: The steamer *North American* was wrecked after running into rocks on Ile d'Anticosti, QC, during thick fog. All passengers were taken safely ashore.



June 27: Destructive wind storms struck the city of Medicine Hat and Provost Alberta – destroying a two-storey house, downed the brick wall of a new separate school and a porcelain factory. In Provost, a church chimney was downed and several barns smashed.

July 3: A telegraph operator in Sackville, NB, was recovering after receiving a heavy electric shock during a torrential thunderstorm the previous day when the telegraph office was struck by lightning. He still felt the effects of the shock 5 days later.

John Patterson and his MSC colleague releasing balloon tethering a Dines meteorograph for recording pressure and temperature near the present site of Toronto's Varsity Stadium circa 1911.

Article: Weather in Canada's First Year

July 3: It was nearly seven weeks since a good rain had fallen on the Ottawa Valley where temperatures soared to 103°F in the noon sun.

July 19: A terrific thunderstorm with heavy rain passed over Kingston, ON. Lightning struck the chimney of a home, moving the cook stove from its position, rolling up the floor of the garret like a scroll, tearing a hole in the bedroom wall, and igniting the house on fire. Outside, lightning split a large stone, hurling a piece 10 m away.

July 24: Residents of Saint John, NB, cleaned up following a terrific thunderstorm. The vividness of the lightning was only surpassed by the loud peals of thunder. Farm buildings near Collian Corner were struck and set on fire. The loss was huge, including the stock of hay and all farming implements stored in the barn.

August 4: Heavy rain accompanied by strong winds and high tides pushed water levels so high that dykes all along the Petitcodiac and Shepody rivers in New Brunswick were breached. The schooner *Quickstep*, lying at Mary's Point, was destroyed. Possible tornadic winds swept through Sackville, inflicting much injury. Gardens were laid waste and trees shorn of their limbs and uprooted.

August 5: One of the worst oil well fires ever in Canada occurred in Petrolia, ON. When the burning oil ran down the creek, a current of air came rushing in. In the centre of the vortex, the whirlwind took smoke into the heavens like "a roll of wool," and the flames, resembling a fiery serpent, whirled 100 m in the air. The awful sound resembled artillery guns.

August 7: A mail carrier on his way from St Francis to Beauce, QC, encountered an afternoon thunderstorm with considerable hail.

August 10: In Halifax, NS, a fierce gale blew for several hours. Gardens were left disfigured, and the destruction to greenhouse glass was extensive. Winds blew down the frame of the new Baptist Church. At Wolfville, the storm made havoc of the beautiful shade trees around Acadia College. Apple and plum orchards throughout the Annapolis Valley were totally destroyed.

August 21: The captain and crew of the schooner *Algerine* watched "stupefied with terror" the descent of an immense meteor into Lake Ontario. Estimated at about 6 m in diameter, the meteor let off a large volume of steam and spray when it hit the water.

September 29: A strong gale blew from the northwest into Sarnia, ON, preventing upward-bound vessels from moving into Lake Huron and causing downward boats to seek refuge in port. Several boats sustained damage, making it necessary to lay over for a few days in Sarnia for repairs.

October 9: The Great Labrador Gale was one of the worst storms ever along the Labrador (NL) coast. Thirty-seven lives and 27 vessels were lost. The famous seal captain William Jackman rescued 27 people, mostly women, from certain death aboard the *Sea Clipper*. Twenty-seven times he waded into the icy gulf waters and huge waves to carry each victim to safety on his back.

October 11: A drought throughout Lambton County, ON, caused wells to dry up, making it difficult for farmers to water their cattle. In some cases, farmers had to drive their stock great distances to the St. Clair River for water.

November 3: A couple living in the station master's house on Front Street in Toronto, ON, narrowly escaped being crushed in their bed when their 3-m-high chimney fell during a windstorm. The woman had gone upstairs, intending to go to bed, but then returned downstairs because she had forgotten something. While she was downstairs, the chimney crashed through the roof.

November 4: A strong gale hit southern Ontario, causing several ship-sinking disasters and building losses. Winds downed several vessels on Lake Ontario with the loss of cargo and at least one life. On Lake Michigan, the *Chieftain* was a total loss after being driven ashore.

November 23: The thickest fog that ever enveloped Fredericton, NB, enshrouded the city. People disappeared as if plunging into outer darkness.

November 24: Bound for Le Havre in France, through the spray of a heavy gale, the *L.C. Owen* sighted a ship named the *Norwood* sinking in the North Atlantic. After a difficult 30-hour rescue, the *L.C. Owen* was able to bring all 25 crew members to safety.

November 26: After the fog and rain and mud of the 2 past days, the weather today has been more agreeable. Farmers are grateful for the rain that fell, and no doubt would have been glad of a continuance for a day or two longer, in order that their exhausted wells might be fully replenished before winter set in." *Quebec City Gazette*

November 29: The long-continued drought with strong prevailing winds contributed to fires in Chatham, NB. Flames spread rapidly and fire broke out around 11 o'clock. In a short time, the whole block of buildings on the south side of King Street was totally destroyed, together with several houses in the square.

Article: Weather in Canada's First Year

November 30: During a gale, the ship *Stag* dropped anchor in the St. Lawrence River, near Trois-Pistoles, QC. The following day, surrounding ice cut her bow. Two days later she went down with a load of grain and 300 tonnes of government rifles. The crew launched 2 life boats: the mate and 23 men in one boat and the captain, pilot, second-mate, and 6 men in the other.

December 6: A severe windstorm in southwestern Ontario sank 2 ships in the St. Clair River. Buildings lost roofs, barns blew down, and fences were scattered. In Plympton, ON, a tree crashed onto a school shortly after the teacher dismissed the children early. A concerned school trustee had persuaded the reluctant teacher to dismiss the school just minutes before the tree came down.

December 7: A poor unfortunate man near Woodstock, ON was assisting in the slaughtering of some hogs ... and on his way home with a butcher's knife in his pocket he slipped on the ice on the street and fell, the knife entering his side and causing death in half an hour. *The Woodstock Sentinel*

December 8: A large ship with a cargo of timber grounded in the St. Lawrence River near Gaspé, QC. Thirteen crew members drowned. Ten others struggled ashore on floating timber but were badly frozen. Crews from other ships delivering winter supplies at the time were also badly frostbitten in the -25°C cold and had to be carried ashore.

December 11: The thermometer at Sarnia, ON, read 18 below zero (-28°C). Along with a keen north wind, the cold in the streets was frightful. The bitter weather had the effect of eliminating all unlawful acts as the police reported not a single offence against the laws had occurred.

December 12: A severe drought reduced water in the Erie Canal in Ontario to record-low levels. A strong northeasterly gale sent Lake Erie waters westward, leaving the Niagara River and its tributaries at their lowest ever. The steamer *International* could not effect a landing, forcing passengers to use ladders to get on and off.

December 13: In Montréal, QC, workers endeavoured to clear the wharves before ice covered them. The St. Lawrence River was rising rapidly. Soldiers were hired to assist in removing the wood and lumber supplies. The floating ice soon became stationary. Fears were also raised that severity of the weather would interfere with the city's water supply.

December 14: "It is now all but certain that the good ... people of the Niagara Peninsula [ON], as well as the scallywags and sinners, and those who take, read and appropriate newspapers without paying for them, will soon be favoured with some good sleighing. It has been snowing since Saturday, one flake every minute..." *The Evening Journal*, St. Catharines

December 18: At around 3:00 AM, an earthquake was felt from Hamilton, ON, to Montréal and Trois-Rivières, QC. The tremor lasted only about a minute, and was strong enough to shake buildings, make dishes rattle, and arouse people from their sleep.

December 21: Information was sketchy, but possibly as much as 80 mm of freezing rain fell in Ontario near eastern Lake Erie and western Lake Ontario. The next day, temperatures rose above the freezing mark, melting much of the accumulated glaze. If all the precipitation was freezing rain, then this would be the record to fall in one day in Ontario.

December 29: From Hudson's Bay Company records at Fort Chimo (now Kuujuaq, NU): "Everything was crisp and cracking with frost. Our very dogs are yelling with cold and water freezing alongside our stoves filled with fire wood. The idea of 3 months more of such weather was not very cheering. Men hauled home fire wood and we were burning it as fast as they could bring it."

December 30: From Hudson's Bay Company records for 30 and 31 December at Fort Chimo: "Everything crisp & cracking with frost, our very dogs are yelling with cold & water freezing alongside of our stoves filled with fire wood, & the idea of 3 months more of such weather is not very cheering ... last of the old year, no abatement of cold. Men hauling home fire wood & we burn it as fast as they can bring it."



About David

David has been employed with Environment Canada's weather service for more than 45 years. His work activities relate to the study of the climate of Canada and to promote awareness and understanding of meteorology. He has published several books, papers and reports. He is the originator and author of the Canadian Weather Trivia Calendar, the most popular calendar sold in Canada, and now in its 30th year. David is the recipient of three honorary doctorates from the universities of Waterloo and Windsor and Nipissing University. In 2001, David was named to the Order of Canada.

50th Anniversary: Interviews

To celebrate the 50th anniversary of CMOS, the Society will be publishing a book, to include a compilation of papers published in the CMOS flagship journal *Atmosphere-Ocean*. The republished papers were selected from all papers published in *Atmosphere-Ocean*, and its predecessor *Atmosphere*, on the basis of being the most-cited papers in the past five years.

In the first three issues of Volume 45 of the CMOS Bulletin, readers can enjoy interviews conducted by CMOS Bulletin Editor Sarah Knight with the authors of the papers included in the book. The book will be available in time for the June CMOS Congress in Toronto.

Interview with Lucie Vincent

Lucie Vincent is the lead author of the paper *Changes in Daily and Extreme Temperature and Precipitation Indices for Canada over the Twentieth Century* (Vincent and Mekis 2006). She also co-authored 2 other papers included in the book: *Temperature and Precipitation Trends in Canada during the 20th Century* (Zhang, Vincent, Hogg and Niitsoo, 2000) and *An Overview of the Second Generation Adjusted Daily Precipitation Dataset for Trend Analysis in Canada* (Mekis and Vincent 2011). Here, she answers questions related to both her 2000 and 2006 papers. Xuebin Zhang offers his own thoughts on their 2000 paper in his interview on page 14.

Q: What motivated you to pursue this area of research?

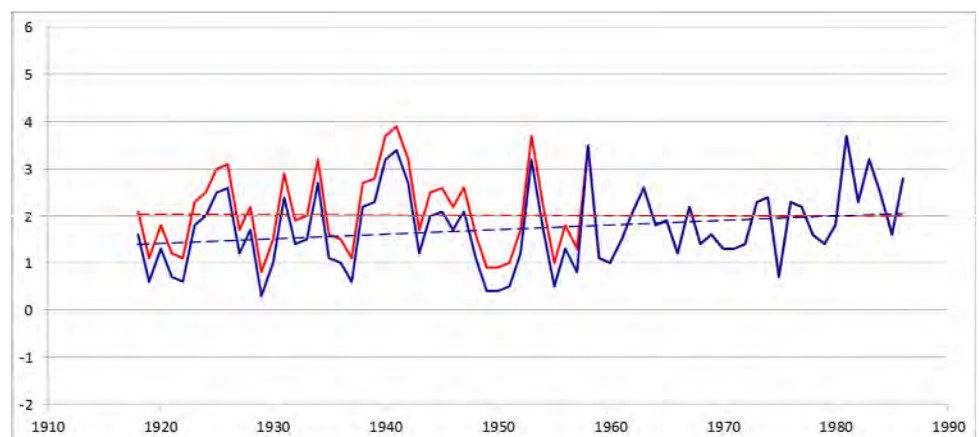
In the 1990's, I was involved in a project to assess climate trends in Canada. Since my education is in mathematics and statistics, I was applying regression models to determine if climate trends at individual climatological stations were statistically significant or not. But soon I realized that the temperature time series showed non-climatic shifts (also called inhomogeneities) due to the relocation of instruments, changes in observing procedures, and automation, which interfere with the proper assessment of climate trends and changes in extremes. Since then, my research has been mainly devoted to the homogenization of the climate data and the analysis of climate trends in Canada.

Q: How has this research informed climatological research in Canada and around the world?

Since the 1990's, climate data homogenization and assessment of changes in climate extremes have become important topics in climate research. Scientists using climate data observations are now aware of the issues affecting climate data and they can better interpret the results of their studies. For example, there are a number of climatological stations where the instruments were formerly located on the roof of a building, at some airports and schools, that have been moved to nearby ground locations. The irradiating temperature of the roofs and walls influenced the surrounding air temperature and the relocation of the instruments to the ground incorrectly led to the assumption that the air temperature was cooling at these sites. Adjusting temperature data was crucial



Screen located on the wall (between windows) where thermometers were placed for observations before 1957; screen located in the front yard where the thermometers were placed between 1957 and 1986, at Vernon Coldstream Ranch.



Annual mean of the daily minimum temperatures before adjustments (red) and after adjustments (blue) at Vernon Coldstream Ranch. The unadjusted data shows a decreasing trend of 0.1°C while the adjusted data shows an increasing trend of 0.6°C for 1918-1986.

50th Anniversary: Interviews

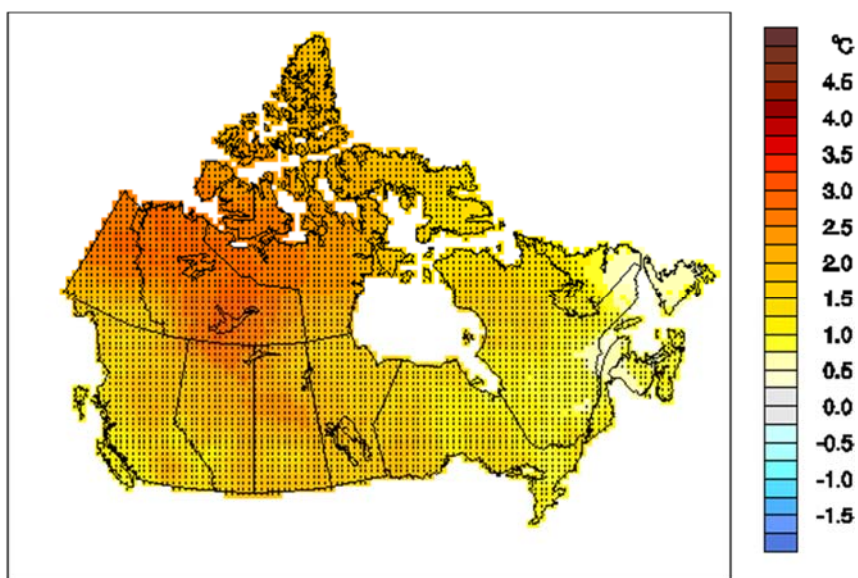
in these cases for a better assessment of the trends. Therefore, it is with more confidence that we were able to present our trends results in our papers, and in particular greatest warming during winter and spring (Zhang, Vincent, Hogg and Niitsoo, 2000), and fewer cold nights, cold day, frost days and more warm nights, warm days and summer days across Canada (Vincent and Mekis 2006).

Q: What do you perceive was the main impact of this research?

It became quickly obvious that detecting inhomogeneities and adjusting climate datasets requires detailed information regarding the instruments in use, observing procedures, and also a lot of time. For this reason, in the early 1990's, we have created the Adjusted and Homogenized Canadian Climate Data (AHCCD) for use in climate research. The data have been used by hundreds of people including scientists from meteorological offices and other federal/provincial agencies, university and high school professors and students, and by the public in general. The data are available at the Government of Canada Open Data portal (<http://open.canada.ca/en/open-data>) and at the Environment Canada website (<http://www.ec.gc.ca/dccha-ahccd/>). Today, scientists recognize that it is preferable to use homogenized/adjusted data for climate change studies and, in particular, for climate trends analysis.

Q: How did this research inform your own goals?

Both studies provide further evidence that, based on long and high quality observational records, the climate is changing in Canada. The changes include a more pronounced warming in winter and spring, increase in precipitation in the north, and decrease in the fraction of precipitation falling as snow in the south. The warming is also associated with fewer cold events and more warm events, more days with precipitation and a reduction in the maximum number of consecutive dry days. No consistent changes were found in extreme precipitation events. Since climate extremes have far-reaching consequences on our society, economy and environment, it is important to continue to develop methodologies to assess changes in extremes events. Since



Trends in annual mean temperature for 1948-2012 (°C for 65 years). Grid squares with trends statistically significant at the 5% level are marked with a dot.

the publication of both studies, my main research goal has been to continue the development of procedures to homogenize/adjust temperature and precipitation datasets, but for daily and sub-daily observations, which are needed for an appropriate assessment of changes in climate extremes.

Q: What are your hopes for climatological research in general in the future?

The climate observing network has changed considerably in Canada since the 1990s due to the downsizing of the traditional network and increasing use of automated systems. The preferred practice when the observing system is replaced is to have parallel observations from the collocated instruments for a period of two to five years in order to develop mathematical relations between the old and new systems, and to derive and apply adjustments if necessary. The collection of parallel observations has been gradually becoming a practice in recent years in Canada. However, this practice should be well recognized and applied each time that a new instrument is used or a new observing procedure is taken place. This should be done especially in the northern and isolated regions of the country where climate observations are of a great value for climate monitoring and studying climate change. My colleagues, Ewa Milewska and Éva Mekis, and I are currently developing methodologies to integrate long-term homogenized temperatures and adjusted precipitations with new measurements taken at automated systems in order to preserve the continuity of the climate records for use in climate change analyses.

50th Anniversary: Interviews



About Lucie

Lucie A. Vincent received her Bachelor's degree in Mathematics from l'Université de Sherbrooke in 1984, and her Master's degree in Statistics from York University in 1990. She has been working as a scientist for Environment Canada since 1984. She has published numerous articles in peer reviewed literature on climate data homogenization/adjustments and climate trends in Canada. She was an associate editor for the AMS (American Meteorological Society) State of the Climate reports for 2008 to 2011. She currently co-leads the CCI (Commission of Climatology) Expert Team on National Climate Monitoring Products (ET NCMPs) supported by WMO (World Meteorological Organization) who develops products and software specifications and requirements for climate monitoring. Lucie is pictured here, in centre, with colleagues Éva Mekis (on left) and Ewa Milewska (on right).

Paper Summary

Changes in Daily and Extreme Temperature and Precipitation Indices for Canada over the Twentieth Century.
L.A. Vincent and É. Mekis, 2006

Lucie Vincent and Éva Mekis analyse the trends and variations in several indices of daily and extreme temperature and precipitation in Canada. The indices are based on homogenized daily temperature and adjusted daily precipitation. Previous studies on climate change in Canada have shown changes in long-term annual and seasonal means and it became pertinent to investigate if the warming in Canada was accompanied by detectable changes in temperature and precipitation extremes. Extreme climate events have the greatest and most direct impact on our everyday lives, community and environment. The results indicate fewer cold nights, cold days and frost days and, conversely, more warm night, warm days and summer days across the country for 1950-2003. The results also reveal more days with precipitation, a decrease in the precipitation intensity and a decrease in the maximum number of consecutive dry days. No consistent changes are found in most of the indices of extreme precipitation. This study also provides further evidence that the warming in Canada has changed some of the precipitation from solid to liquid which in turn can have a serious impact on some of the economics activities in Canada such as agriculture.

Interview with Xuebin Zhang

Xuebin Zhang is the lead author of the paper *Temperature and Precipitation Trends in Canada during the 20th Century* (Zhang, Vincent, Hogg and Niitsoo, 2000). This important paper shows clearly the long-term changes in Canada's climate.

Q: How did you get interested in this area of research?

I obtained a PhD in Portugal at the University of Lisbon, with a specialization in climatology. I was interested in climate studies. Prior to 1995, my work was about the impact of climate change on water resources as well as construction of climate change scenarios. After moving to Canada at the end of 1995 I was looking for a job, and I was very lucky to be offered a Visiting Fellowship by the Climate Research Branch at the time. The first project I did in Canada led to this paper.

Q: What was the main impact of this research, and how was it used by other researchers in Canada, or around the world?

This was the first paper that comprehensively documented long-term trend in Canadian temperature and precipitation. The paper was very simple, with two main components. One, was methodological development. There we showed a simple method to reliably and robustly estimate trends in climate series. Because of this (I *think*), the paper has generated quite a few citations. Most of the citations are in the field of climate research, where the method we developed is used. The other component is that it was the first paper to systematically document long-term changes in Canadian temperature and precipitation. This has played an important role to inform the climate research community, and to some extent policy makers and the general public about long-term changes in Canadian climate that have been happening.

50th Anniversary: Interviews

Q: How did this work inform your own research?

The paper showed clear trends in climate. This motivated the desire to understand the underlying causes of the trend and has led to my many-year effort in the field of climate change detection and attribution.

Q: What are your research plans for the future?

My main research will focus on understanding the causes of observed changes in the climate as well as future evolution of climate, in particular climate change at regional and local scale that is most relevant to impacts.

Q: What do you see as some of the major issues associated with climate change?

There are many important issues the climate community faces. The World Climate Research Program has identified important research areas as 7 Grand Challenges that require international partnership and coordination and that yield “actionable information” for decision makers. These grand challenge projects include melting ice and global consequences, clouds, circulation and climate sensitivity, carbon feedbacks in the climate system, understanding and predicting weather and climate extremes, water for the food baskets of the world, regional sea-level change and coastal impacts, and near-term climate prediction.

Q: Could you comment on which of these 7 Grand Challenges you see as particularly relevant within the Canadian context?

This is indeed a bit too difficult to answer as these high priority areas are also related and linked. For example, while climate extremes are very important to the impacts, understanding changes in extremes and providing robust projection of future extremes do require improved models that have sufficiently accurate and realistic cloud scheme and that simulate large scale circulation as well as its influence on surface climate well.



About Xuebin

Dr. Xuebin Zhang is a Senior Research Scientist with the Climate Research Division, Environment and Climate Change Canada.

He served as lead authors for IPCC assessment reports. His current research focuses on past and future changes in climate extremes.

Paper Summary

Temperature and Precipitation Trends in Canada during the 20th Century: X. Zhang, L.A. Vincent, W.D. Hogg and A. Niitsoo, 2000

This paper analyses trends in Canadian temperature and precipitation during the 20th century using, for the first time, temperatures homogenized for site relocation and changes in observing programs, and precipitations adjusted for known instrument changes and measurement program deficiencies. The data was first interpolated to a 50 × 50 km grid to take into account the uneven distribution of the station data which is sparse in northern Canada (north of 60°N). From 1950-1998, a distinct pattern of warming in the south and west, and cooling in the northeast regions of the country was found in winter and spring. Across Canada, precipitation increased by 5% to 35%, with significant negative trends in the southern regions during the winter. The ratio of snowfall to total precipitation increased, with negative trends in southern regions during the spring. The causes of the different spatial and temporal trends are not discussed here but there is some evidence of agreement between the trends observed in Canadian climate and those predicted by the Global Climate Models incorporating an increase in atmospheric greenhouse gases.

50th Anniversary: Interviews

Interview with Nigel Roulet

Prof. Nigel Roulet is one of the authors on the 2000 paper *Parameterization of peatland hydraulic properties for the Canadian Land Surface Scheme (CLASS)*. This was the first inclusion of organic matter into a land surface package, providing a significant contribution to the field of climate modelling.

Q: What motivated you to pursue this area of research?

When I was working on my PhD on low arctic hydrology, the catchment I was working on had deposits of peat in the valley bottoms. This completely altered the 'typical' permafrost hydrology we had expected from my supervisor's work in the high arctic. I soon realized that very few people had worked on peatland hydrology, but peatlands were a very important land cover of Canada – 12% of Canada is covered with peat. So I then began working on peatland hydrology and it became obvious that as the peat accumulated, it modified the hydrology that allowed the peatlands to originally form. Fast forward 30 years, and we now know peatlands are complex ecosystems that are self-regulating because of the negative feedbacks between the production of peat and its accumulation and the hydrology of the peatland. This makes these ecosystems unique when studying climate change because the self-regulation gives them a resilience in some cases. The motivation of the work in the paper in Atmosphere-Ocean came from recognizing that peatlands contain about one third of the world's soil carbon and the maintenance of that vast store of carbon was dependent on the peatlands remaining wet, and that climate change might lead to changes in wetness of peatlands. I thought it was fairly important to try and get the properties of peat into the Canadian Land Surface Scheme (CLASS) since peatlands were such an important land cover type. The first step of this process was to get the parameters for peat and organic soil into the CLASS.

Q: What do you perceive was the main impact of this research?

Our research was the start, enabling climate modellers to get peatlands into climate models. This allows us to now examine the sensitivity of the vast carbon stores in northern peatland to climate change. Based on that work and our simulations we now know that bog like peatlands are not very sensitive to climate change but are highly sensitive to land-use change that alters their hydrology. Once their hydrology is changed they become more sensitive to changes in climate. The bog-like peatlands represent about 70% of northern peatlands in Canada. Our modelling shows us that the fen-like peatlands are very sensitive to climate change and could become net carbon sources to the atmosphere with climate change. We are still working on the size of this feedback.

Q: How, since publication, has this research informed other research in this area, in Canada or around the world?

The parameters synthesized in the paper have been incorporated into CLASS and are in all the subsequent versions of CLASS, therefore they are in the Canadian climate and earth systems models. We first developed



Peatlands in the Hudson Bay Lowlands.



The eddy covariance tower at the Mer Bleue peatland, Eastern Ontario – the longest running carbon observatory for a peatland in the world.

50th Anniversary: Interviews

a model called the Peatland Carbon Model (PCARS), published in 2001 and 2002. Subsequently, we developed the McGill Wetland Model (MWM) as part of the development of the Canadian Earth System Model. Just recently the scientists at the Canadian Centre for Climate Modelling and Analysis (CCCma) have developed a full carbon land surface scheme based on this work and our subsequent peatland models (Wu et al., 2016).

Our work with MWM is:

Wu, J. and N. T. Roulet (2014). "Climate change reduces the capacity of northern peatlands to absorb the atmospheric carbon dioxide: The different responses of bogs and fens." *Global Biogeochemical Cycles* 28(10): 1005-1024.

Wu, J., N. T. Roulet, T. R. Moore, P. Lafleur and E. Humphreys (2011). "Dealing with microtopography of an ombrotrophic bog for simulating ecosystem-level CO₂ exchanges." *Ecological Modelling* 222(4): 1038-1047.

Wu, J., N. T. Roulet, M. Nilsson, P. Lafleur and E. Humphreys (2012). "Simulating the carbon cycling of northern peatlands using a land surface scheme coupled to a wetland carbon model (CLASS3W-MWM)." *Atmosphere - Ocean* 50(4): 487-506.

Wu, J., J. Sagerfors, M. Nilsson and N. Roulet (in review). "Six Years Simulation of Carbon Fluxes for a Minerotrophic Mire (poor fen) in Northern Sweden using the McGill Wetland Model (MWM)." *Journal of Geophysical Research - Biogeoscience*.

Most of the citations for our paper have been from other modelling groups struggling to get peatlands into their climate models and land surface schemes.

Q: What do you think is the main message from this body of research?

This work has told us that we should attempt to keep peatlands intact and not affect their hydrology if we want the carbon stored in them to remain stored.

Q: What are your research plans for the future?

We will continue to work on this problem. We have developed a simpler version for running long-term climate studies over the Holocene and we continue to refine our McGill Wetland Model. We are modifying it to include dynamic vegetation and nitrogen and phosphorus cycles.

Q: What are your hopes for land surface-atmosphere research in general, in the future?

I hope the models begin to incorporate land-use change, because over 75% of terrestrial landscapes are influenced in some way by human activities and these changes make the surface much more sensitive to change – i.e. they lose their natural resilience.



Peatlands collapsing due to permafrost thaw.

50th Anniversary: Interviews

Q: Climate change is a political, social and environmental focal point of this century. What is your opinion on what should be prioritized?

We need to build in resilience into all the decisions we make. Making the systems we rely on too brittle is definitely going the wrong direction. We have to develop a way to incorporate adaptive management into all our decisions. We manage far too linearly and ignore the fact that most of the system we rely on are complex systems.

Reference

Wu, Y., D. L. Verseghy and J. R. Melton (2016). "Integrating peatlands into the coupled Canadian Land Surface Scheme (CLASS) v3.6 and the Canadian Terrestrial Ecosystem Model (CTEM) v2.0." *Geoscientific Model Development* 9(8): 2639-2663.



About Nigel

Dr. Nigel T. Roulet is a James McGill Professor of Biogeosciences and Chair of the Department of Geography, McGill University. Nigel's research interests focus on the interactions among hydrology, climatology, and ecosystems processes in peatlands and forested catchments of the temperate, boreal, and arctic regions. He has published over 200 scientific papers, book chapters and monographs and was a contributing author to the 2nd through 4th scientific assessments of climate change by the United Nation's Intergovernmental Panel on Climate Change. He is currently an Associate Editor of *Global Biogeochemical Cycles*, *Hydrological Processes*, and *Ecosystems* and has been an associate editor of *Wetlands* and the *Journal of Geophysical Research – Biogeosciences*. In November 2014 Nigel was inducted as a member of the Academy of Science of the Royal Society of Canada.

Paper Summary

Parameterization of peatland hydraulic properties for the Canadian Land Surface Scheme: Letts, M.G., Roulet, N.T., Comer, N.T., Skarupa, M.R. Verseghy, D.L., 2000.

The authors write on the development of the organic soil parameters for the Canadian Land Surface Scheme (CLASS). Most land surface packages for climate models assume the soils comprise sand, silt and clay, but much of the northern latitudes are covered with soils that are largely made up of organic material. For example, twelve percent of the land surface of Canada, and similar areas of Fennoscandinavia and Russia, are covered with peatlands. The thermal and hydraulic properties of organic matter are very different than those of mineral soils largely due to the high porosity of organic matter. At the time this was the first inclusion of organic matter into a land surface package, but many climate models now use a similar parameters set. Without the inclusion of organic matter in climate models the presence and absence of permafrost and the annual thermal cycle cannot be simulated with any degree of confidence.



Richard Leduc, Ph.D.
Meteorologist

Research
and consulting
Meteorology
and air quality

4071, rue des Villas
Quebec, QC, Canada G1Y 1V5
418-657-4054 • 418-930-4054
rleduc@airmetscience.com

www.airmetscience.com



Richard Leduc, Ph.D.
Météorologiste

Recherche
et services conseils
Météorologie
et qualité de l'air

4071, rue des Villas
Québec, QC, Canada G1Y 1V5
418-657-4054 • 418-930-4054
rleduc@airmetscience.com

www.airmetscience.com

Report: Seasonal Outlook for Spring 2017

Seasonal Outlook for the spring 2017 (MAM) based on the official CanSIPS forecast issued on the 1st March 2017 / Prévission saisonnière pour le printemps 2017 (MAM) basée sur la prévision officielle du système SPISCan, produite le 1 Mars 2017

Marko Markovic¹, Bill Merryfield², Bertrand Denis¹, Marielle Alarie¹; 1 - CMC, Montreal; 2 - CCCMA, Victoria

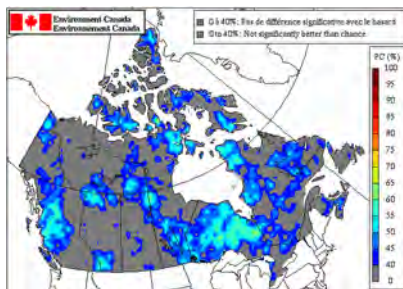
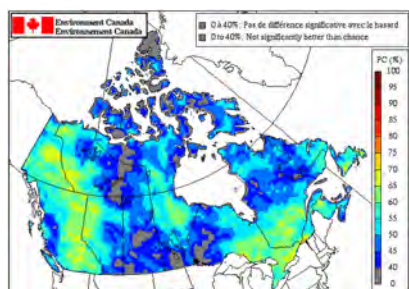
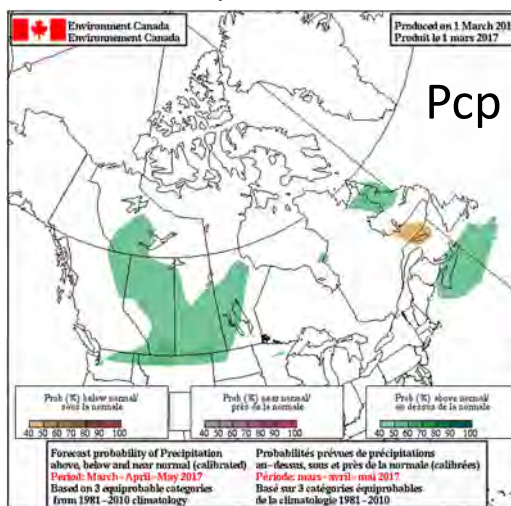
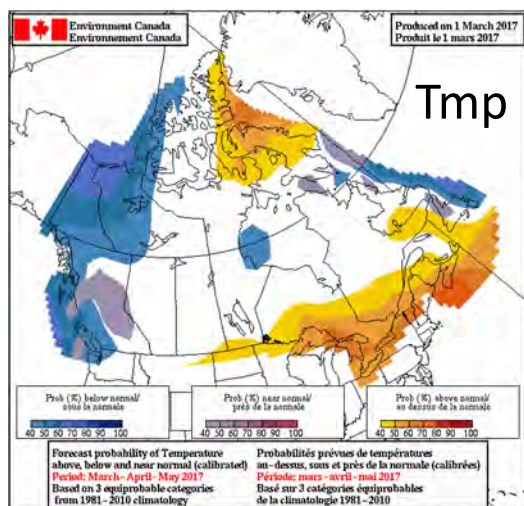
For more recent seasonal forecast (Apr-May-Jun) please visit http://mete.gc.ca/saisons/prob_e.html
 Pour une prévision plus récent (Avril-Mai-Juin) consultez http://mete.gc.ca/saisons/prob_f.html

Above normal temperature spring is expected in southeastern Canada. The highest probabilities (60% and +) for such a forecast are in the Maritimes and over the Great Lakes. Southern QC and central ON have the expectancy of at least 40% of above normal values. Equal probability chances are expected over the central prairies. Near normal temp is expected in central BC while the Canadian North West and coastal BC have 40-60% of chances to get below normal spring.

Un printemps plus chaud que la normale est anticipé à l'est du pays. Les probabilités les plus élevées (60% et +) sont anticipées sur le sud-ouest des Maritimes et les Grands Lacs. Sur le sud du QC et au centre de l'ON, les probabilités sont à 40%. Les probabilités égales pour la température sont attendues ce printemps sur les Prairies. Les régions côtières du BC et au NO du pays ont au moins 40-60% de chance d'observer des valeurs au-dessus de la normale.

Elevated chance of above normal precipitation over central prairies? There is >40% probability for this in southern and central SK and AB. Southeastern parts of BC, and maritime provinces are also expected to have above normal values with a probability of around 40%.

Possibilité de voir des précipitations au-dessus de la normale sur la majorité des Prairies? Il y a plus de 40% de probabilité que les préc. soient au-dessus de la normale, surtout pour la SK et l'AB. Les régions au sud des provinces Maritimes ont aussi une valeur de 40% de chance d'avoir des préc. au-dessus de la normale.



Historical Skill, Tmp.
Habilité historique, Temp.

Historical Skill, Pcp.
Habilité historique, Préc.

CanSIPS MAM17 forecasted Indices:
 Niño3.4 = 0.56 (El Niño watch)
 PDO = - 0.45 (weak negative phase)

Les indices climatiques prévus par le SPIS-Can, DJF16/17:
 Niño3.4 = 0.56 (El Niño vigilance)
 PDO = - 0.45 (indice faible négatif)

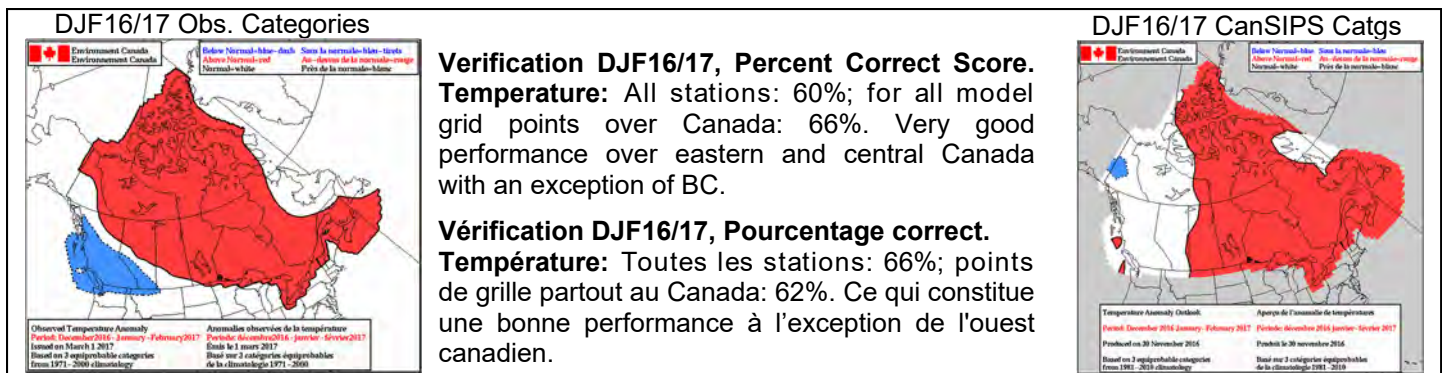
What will influence the next season? We are currently experiencing neutral ENSO conditions in the central equatorial Pacific. These conditions have no significant impact over Canada in spring. However, ECCC predicts positive ENSO conditions (+0.5 °C) to develop this spring and therefore suggests **El Niño watch** for the following months. According to the longer lead seasonal forecast issued by International

Qu'est-ce qui influencera le climat la saison prochaine? Nous vivons actuellement des conditions neutres sur le centre du Pacifique Équatorial. Ces conditions n'auront pas une incidence sur le Canada ce printemps. Cependant, ECCC prévoit que des conditions positives d'ENSO (+0.5°C) se développeront ce printemps et suggère de surveiller l'évolution d'un **El Niño** dans les mois qui suivront. Selon les

Report: Seasonal Outlook for Spring 2017

Research Institute (IRI), there is a probability of ~40% that **El Niño** could develop later this summer. **PDO** index is expected to become negative this spring, moderately influencing coastal BC regions towards cooler temperatures. Negative **NAO** index (according to the NOAA/CPC prediction) is forecasted at least until mid-March which is in accord with the **Sudden Stratospheric Warming** event observed in the end of February. This event could bring the inflow of cold polar air into the Canadian west, northwest and over central parts of Canada during the first three weeks of March.

prévisions saisonnières publiées par l'International Research Institut (IRI), il y a une probabilité de ~40% qu'un El Niño puisse se développer plus tard dans l'année. L'indice **PDO** devrait être négatif ce printemps. Cela signifie que les régions côtières de l'ouest canadien seront sous l'influence de températures légèrement plus froides par rapport à la normale. L'indice négatif de **NAO** (calculé par le NOAA/CPC) est prévu jusqu'à la mi-mars, en accord avec un **Réchauffement Rapide de la Stratosphère** qui a été observé vers le fin du février. Cette événement peut apporter de l'air froid provenant de l'Arctique sur l'ouest et nord-ouest du Canada aussi comme sur les régions centrales du pays. Cette influence est attendue pour les trois premières semaines de mois du mars.

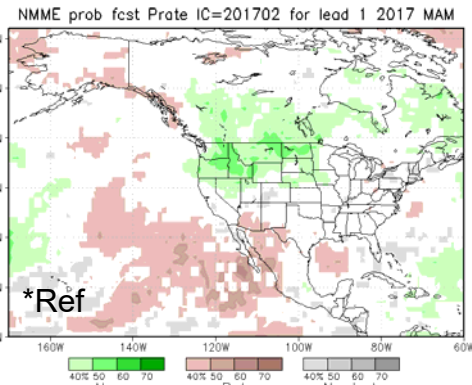
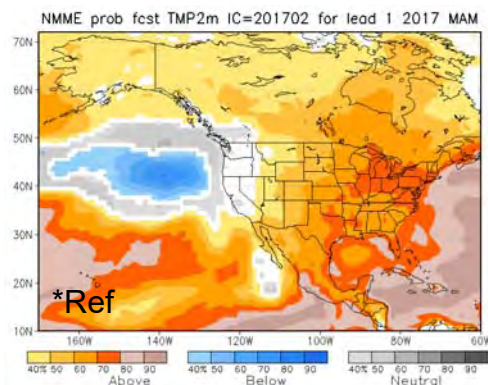


Seasonal forecast by other centers

Temperature: according to the NMME (North American Multi Model Ensemble, lead 1 month), probability of above normal temperatures (>40%) is forecasted all over Canada with an exception of the southwest coastal BC. In accord to CanSIPS, the highest probabilities for such a forecast are over the Great Lakes, southern QC and Maritimes. Contrarily to CanSIPS, near normal temperatures are expected in coastal BC and above normal values over NW Canada. Difference between these two prediction centers is also seen for the central Prairies where NMME predicts likely above normal spring. **Precipitation:** There is an overall agreement between CanSIPS and longer lead forecast from NMME (lower figure), over most Canadian regions such as central Prairies and Maritimes, where both systems are forecasting ~40% probability of above normal precipitation. Slight differences are seen in northern QC and eastern BC where NMME forecasts above normal precipitation values for the following spring.

Les autres centres

Températures: selon le NMME (North American Multi Model Ensemble) (préavis de 1 mois), on a une probabilité d'avoir des valeurs au-dessus de la normale (>40%) pour toutes les régions du pays, à l'exception des régions côtières du sud-ouest de la CB. En accord avec le SPISCan les probabilités les plus fortes sont pour les régions des Grands-Lacs, au sud du QC et les Maritimes. À l'inverse de SPISCan, les températures près de la normale sont anticipées dans les régions côtières de la CB et les valeurs au-dessus de la normale au nord-ouest du pays. En plus, les différences entre deux systèmes de prévision sont observées dans les Prairies centrales où NMME prévoit des valeur au-dessus de la normal pour ce printemps. **Précipitations:** En général, on remarque un bon accord entre les prévisions du SPISCan et celles (avec un préavis plus long) fournies par le NMME (figure en bas), pour la plupart des région au Canada, comme les Prairies et les Maritimes, où les deux systèmes



*Ref: <http://www.cpc.ncep.noaa.gov/products/NMME>

CMOS Congress Updates



ANNOUNCEMENT: Seeking story ideas for press and public outreach

Sarah Knight, Editor of the CMOS Bulletin SCMO, will be acting as a temporary communications officer for the upcoming CMOS Congress in Toronto.

CMOS has a tremendous amount to offer Canadians, as our changing climate puts issues that were once confined mostly to conversations within scientific circles, out in to mainstream media. This congress is happening at a key juncture both in CMOS history (the year of the 50th birthday of the Society), and in Canadian history as our country celebrates its 150th. The future is, of course, history yet to be written. This is where YOU, CMOS members, could play a role in shaping the future by sharing your research, ideas, and opinions on the atmospheric, climate, weather and ocean topics that affect us all.

If you have a research story to share, or an informed “expert” opinion on something that is currently making headlines, we can help you write your piece and get it out to the press. Contact us!

If you have an interest in social media, follow the congress (@cmos2017), and consider joining our retweet team. If you use Twitter or Facebook to share your scientific messages please let us know, so we can follow and promote you.

Sarah will be working to get the CMOS Congress, and in turn the Society and its members and mission, into the public realm through the press and social media. But for this effort she needs YOU!

All ideas are welcome to bulletin@cmos.ca.

VOLUNTEERS WANTED FOR THE 51ST CMOS CONGRESS

Would you like to:

Meet experts in meteorology and oceanography?

Make connections with government, academic and industry leaders in atmospheric, ocean and earth sciences?

Gain organizational experience and have fun in the process?

If so, **join the CMOS Congress team as a volunteer at the Toronto Congress**, June 4th to 8th, at the Downtown Hilton Hotel.

Sign up using the on-line Google form: <https://goo.gl/forms/7b5oUiZhmHV8MST32>.

For more information contact cmos2017volunteer@gmail.com.

50th Anniversary: Birth of the CMOS Logo

Logo Vignette from 34 Years Ago

By Bob Jones, CMOS Archivist

As we celebrate our 50th Anniversary, it might be interesting to look back at how the present CMOS logo was chosen.

In 1982, members were asked to submit their own designs to replace the "snowflake" logo with a replacement hopefully to include oceanography which was added when CMS became CMOS in 1977. Following a period where many variations were received, Council or the Executive chose 30 of them and put it to a vote by members in 1983. Here you will see pages from the October 1983 *CMOS Newsletter* (forerunner to the *CMOS Bulletin*) where members were asked to choose from the 30 designs. The Newsletter header shows the old logo.

A ranked ballot was printed allowing ten choices. We can't imagine the paper work, probably led by then Executive Director Uri Schwarz, to sort, rank and compile the final choice(s) which were short listed and approved by Council in 1984. The winning design was supported by a good majority of those replying to the mail ballot. The final logo was designed by Mrs. Helga Hardy based on the winning ballot entry. It began to appear in CMOS publications by mid 2004.



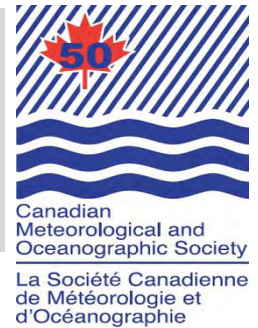
Can you pick out the logo(s) which guided Mrs. Hardy in her design of the final version?



50th Anniversary: Formation of the CMS

Our archivist (Bob Jones) has uncovered the actual ballot and the results of the vote at the Annual General Meeting (AGM) when members received the ballot results and voted to form the CMS.

The actual ballot used and an excerpt from the minutes of the 26th Annual General Meeting of the Canadian Branch of the RMS, held at the University of Sherbrooke, P.Q. June 9, 1966, follow.



4. A NEW CANADIAN METEOROLOGICAL SOCIETY

Mr. E.J. Axton presented the results of the postal ballot as prepared by the National Executive. Of approximately 400 ballots that were distributed to the members, only 131 answers were received. 102 members were in favour of a new Canadian Society, and 29 members expressed disfavour of such a society. Of the 102 in favour, 78 elected to form the new society entitled "The Canadian Meteorological Society", and 24 "The Canadian Association of Atmospheric Sciences". After a brief discussion, Professor B.W. Boville introduced the resolution "Notice of Motion" that had been printed and distributed to those present.

The "Notice of Motion" read as follows:

Be it resolved that:

- (a) *the Canadian Meteorological Society be founded at this meeting; the new society to consist of the same membership as the Canadian Branch in 1966; the new society to operate under the Constitution and By-Laws as published in the Winter 1966 issue of ATMOSPHERE (Vol. 4, No. 1), but that all action under the By-Laws be held in abeyance until January 1, 1967.*
- (b) *the Executive Committee of the Canadian Branch petition the Council of the Royal Meteorological Society to dissolve the Canadian Branch as of December 31, 1966, and to arrange the transfer of funds held by the Canadian Branch to the Canadian Meteorological Society on that date.*

Dr. Orvig seconded the Motion.

Professor Brewer then proposed an amendment to the motion to read - "the new society to consist in 1966 of the same membership and have the same officers as the Canadian Branch in 1966". Seconded by Mr. D. Boyd. After a lengthy discussion, during which Dr. Clodman, Dr. Maybank and Professors Gunn, Boville and Hitschfeld spoke at length, the amendment to the motion was voted on. Motion CARRIED.

Dr. Munn then asked *Dr. Robinson to address the meeting. Dr. Robinson pointed out that the parent society looked favourably on the Canadian Branch breaking away from the Society, and hoped that reciprocal visits could be arranged between the societies of the two countries and that favourable and fruitful discussions would materialize.

A rather lengthy and sometimes detailed discussion then took place on the amended motion. When the vote finally took place, it was CARRIED 68-4.

A motion was then tabled by Dr. Andrew Thomson, which read: "The Executive Committee expresses its gratitude to the Royal Meteorological Society for its assistance in the original formation of the Branch, its continued help through its existence, and hopes that this cooperation and collaboration will continue"

Professor Brewer seconded the motion and it was CARRIED unanimously.

A further motion was then tabled by Professor Hitschfeld, which read: "Resolved that the Canadian Meteorological Society considers itself the successor of the Canadian Branch of the Royal Meteorological Society, and the inheritor of the many and varied activities of the Royal Meteorological Society in Canada. Resolved further that the Royal Meteorological Society be asked to recognize the Canadian Meteorological Society as the successor of the Canadian Branch".

Seconded by Dr. Maybank and CARRIED unanimously.

* Archivist's note: Dr. G.D. Robinson was President of the RMS at that time and was in attendance at the Sherbrooke AGM.

THE BALLOT

PART A - Are you in favour of dissolving the Canadian Branch of the Royal Meteorological Society, and forming a Canadian meteorological society on or about July 1, 1966, the new society to operate under the Constitution and By-Laws as published in this issue of ATMOSPHERE?

Yes ----- No-----

PART B - If it is decided to form a new Canadian meteorological society, the name should be:

(a) Canadian Meteorological Society -----

(b) Canadian Association for the Atmospheric Sciences-----

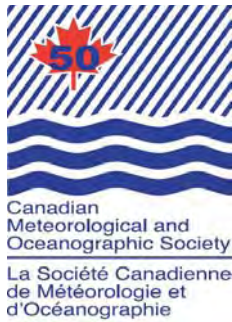
* * * * *

TO BE COUNTED - BALLOTS MUST BE RETURNED TO THE RECORDING SECRETARY (MR. E. J. AXTON, METEOROLOGICAL OFFICE, 315 BLOOR STREET WEST, TORONTO 5, ONTARIO), ON OR BEFORE APRIL 30, 1966.

50th Anniversary: Historical Highlights of CMOS

Excerpts from: Atmosphere Volume 5, 1967

Compiled by Richard Asselin, Former Director, CMOS Publications, Member of Ottawa Centre



THE WAY FORWARD

"Canada has very special needs for meteorological science. It behooves the society to examine these needs and to give itself an additional purpose, namely to advance the science of meteorology in the service of Canada. ...some meteorology should be taught in schools.

Looking to the future, therefore, the society must aim at providing common ground on which all who are concerned with physical events in the atmosphere can meet to discuss their problems and draw on one another's experience.

At present, the membership of the society is mainly composed of professional meteorologists most of whom are concerned with the atmosphere alone. Only a few are concerned with the interactions of the atmosphere and our environment. The purpose then of establishing our own society is to widen the membership to include those whose main interest includes other matters and who see the significance of meteorology and who wish to advance both meteorology and their own special sphere of interest."

"The Taxation Division has been approached, but were not encouraging about having C.M.S. fees registered as tax-deductable [sic]. They have promised to give the matter further study."

"The results of the questionnaire that was sent to all members of the Canadian Branch of the Royal Meteorological Society last fall are, up to March 7, as follows: 430 Questionnaires sent out; 220 Remaining with R. Met. S.; 315 Joining C.M.S."

FIRST NATIONAL CONGRESS OF THE CANADIAN METEOROLOGICAL SOCIETY

Carleton University, Ottawa, May 24-26, 1967. *"As was the case with the Canadian Branch, Royal Meteorological Society, the Congress will be held with the Conference of Learned Societies."*

There were 28 papers in 6 sessions on Cloud and Precipitation Physics, Dynamic Meteorology, Applied Meteorology and Climatology, Upper Atmosphere and Meteorology Today in parallel with Winds and Turbulence, and Meteorology and the Future. *The "sessions will be held in Alumni Theatre B in Southam Hall. This theatre seats 225 and is most suitable; the banquet-luncheon will be held in the University Dining Hall. The cost will be \$2.50 per person."* No report on attendance or significant events has been found, but a photo showing 94 participants (most of them identified by name) is available on the CMOS web site.

ATMOSPHERE

The first policy on authors' "reprints" is formulated (50 free, etc.).

What Next? ...there were two points of view regarding the [future] character of ATMOSPHERE. One: it should not contain anything scientific; the other was diametrically opposed, that ATMOSPHERE should be in competition with the JOURNAL OF APPLIED METEOROLOGY, or THE QUARTERLY JOURNAL OF THE ROYAL METEOROLOGICAL SOCIETY. *"We feel that both of these are unrealistic. ... in our present circumstances, a professional journal is one that we are far from being able to afford. This seems to us to be a long-term goal of merit, but something that will take many years to properly achieve."*

We feel that our present path is the proper one. General articles, survey articles, news of the Society - these are things that fit in with our concept of what we can be at this point in time."

[from this point on, most of the content of ATMOSPHERE has been scientific articles, some by foreign authors]

For the first time, 4 issues were published this year.

WEATHER 50 YEARS AGO

THE WEATHER THAT WAS – 1966, and SOME HIGHLIGHTS OF CANADIAN WEATHER IN CENTENNIAL YEAR 1967 by M.K. Thomas, both in Volume 5, no 2 of ATMOSPHERE form a precedent for the more recent practice of publishing the annual review of the 10 weather stories by David Philips.

[Thomas also published CENTENNIAL WEATHER 1967, in Volume 6, no1]

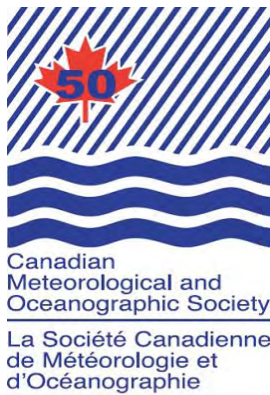
STUDENT'S PRIZE

"Members of the Society are asked to keep in mind the new policy regarding a Student's Prize adopted at Congress last spring. Under this new policy, members are asked to propose a student for the prize based on an especially worthwhile contribution, considering the level of education and experience. In this context, a post-baccalaureate "student" is not considered eligible for this prize."

LA SOCIÉTÉ DE MÉTÉOROLOGIE DE QUÉBEC

« La Société de Météorologie de Québec a été fondée officiellement le 14 octobre 1964 lors d'une deuxième assemblée générale des personnes intéressées directement ou indirectement à la météorologie et à ses applications. -G. Oscar Villeneuve »

50th Anniversary: Golden Jubilee Fund



Turning CMOS 50th Anniversary Celebrations into Action

Plans are continuing to develop to celebrate the 50th anniversary of the creation of the Canadian Meteorological Society (CMS) and the 40th anniversary of the addition of the oceanographic disciplines to create the Canadian Meteorological and Oceanographic Society (CMOS). The anniversary date was January 1, 2017, but we will recognize this important milestone many ways over the coming months.

During the last 50 years, CMOS and its members have made invaluable contributions to Canadian and global science. They have improved the safety of Canadians and assisted economic advancement in Canada. To celebrate these achievements, CMOS is planning a series of activities for 2017 including:

- a public webcast by prominent scientists or spokespersons in collaboration with the Canadian Climate Forum, to provide credible scientific information on climate change to Canadians;
- special sessions at the Toronto Congress in June 2017, with invited speakers, international guests and media publicity; and
- a special publication highlighting the best of *Atmosphere-Ocean* over the years, showcasing the “state of the art” of our disciplines.

The Council of CMOS has created the Golden Jubilee Fund for 2016-17 that will provide CMOS with the resources to showcase our rich history and our sciences through these activities. A tax-deductible donation to the Golden Jubilee Fund will offer individuals, organizations and companies the opportunity to support CMOS in our ambition to be more visible as we celebrate our special anniversary.

Please consider making a donation. You can donate today in the Member Area of the CMOS web site (preferred method) or by using the DONATE ONLINE NOW button on the CMOS home page (www.cmos.ca). Donations will be accepted any time in the coming year, but your early consideration of this venture is important.

CMOS thanks you for your support. Watch the CMOS Bulletin and CMOS web site for updates on these and other 50th anniversary activities.

Martin Taillefer, CMOS President

Concrétiser les célébrations du 50^e anniversaire de la SCMO

Nous continuons de planifier les célébrations du 50^e anniversaire de la fondation de la Société de météorologie du Canada (SMC) et du 40^e anniversaire de l'ajout des sciences de la mer, qui mena à la création de la Société canadienne de météorologie et d'océanographie (SCMO). La date exacte de l'anniversaire était le 1^{er} janvier 2017, mais nous soulignerons cet important jalon de plusieurs façons, au fil des mois.

Au cours des 50 dernières années, la SCMO et ses membres ont considérablement contribué aux sciences canadiennes et mondiales. Ils ont renforcé la sécurité des Canadiens et participé à l'avancement économique du pays. Afin de célébrer ces réalisations, la SCMO planifie une série d'activités pour l'année 2017, y compris :

- Un web émission publique mettant en vedette d'éminents scientifiques ou porte-paroles, et ce, en collaboration avec le Forum canadien du climat, afin d'offrir aux Canadiens une information scientifique crédible sur les changements climatiques;
- Des séances spéciales au Congrès de Toronto en juin 2017, comprenant des conférenciers, des invités internationaux et une campagne publicitaire dans les médias;
- Une publication spéciale qui souligne le meilleur d'*Atmosphere-Ocean* et témoigne de la fine pointe de nos domaines.

Le conseil de la SCMO a créé le Fonds du jubilé pour l'année 2016-2017, afin de nous fournir les moyens de présenter la riche histoire et les sciences de la célébrons cet anniversaire spécial.

S'il vous plaît envisager de faire un don. Vous pouvez le faire dès aujourd'hui dans l'Espace membres du site Web de la SCMO (méthode préférée), ou en cliquant sur le bouton DON EN LIGNE, sur la page d'accueil de la SCMO (www.scmo.ca). Nous accepterons les dons tout au long de l'année, mais les dons hâtifs s'avéreront les plus utiles.

La SCMO vous remercie de votre soutien. Consultez le *Bulletin* et le site Web de la SCMO pour vous tenir au courant des activités du 50^e anniversaire.

Martin Taillefer, Président de la SCMO



A Farewell to Ice

By Peter Wadhams

Published by Allen Lane Penguin Random House UK
Hardcover 240 pages ISBN 978-0-241-00941-3 \$42.95CAN

Book Reviewed by John Falkingham¹

Editor's note: This book was also reviewed by Paul LeBlond in the December issue of the Bulletin (Vol. 44, No. 6). Its subject matter certainly warrants attention, and here John offers his thoughts, which are very much aligned with Paul's, on why this book is a well-written and important read.

Within the sea ice research community, the name Peter Wadhams is legendary. Peter is one of a handful of scientists who have studied sea ice extensively from above, from below, and from under their boots. His career spans 5 decades and includes more than fifty expeditions to both Polar Regions. Witnessing first-hand the startling disappearance of Arctic sea ice, Peter has become an outspoken and eloquent advocate of the need to address climate change in a significant manner. The title of this most recent book, which he gives with apologies to Hemingway, is as much a personal good-bye as a lament to a global tragedy.

In the short first chapter, "A Blue Arctic", Peter recalls some of his early research on sea ice in contrast to observations of the past two decades. This sets the stage for the call to action on climate change with which he closes. The second chapter, "Ice, the Magic Crystal", is devoted to a brief but accurate description of the physics of ice. Peter accomplishes this with plain language and real-world examples that scientists and non-scientists alike will appreciate.

In the next two chapters, Peter describes the history of ice on Earth from the first glaciation over 2 billion years ago. Over this discussion, he cements the connection between ice ages, global atmospheric temperatures, and greenhouse gas concentrations, laying the foundation for his later conclusions.

Chapter 5 provides a meticulous description of the greenhouse effect complete with graphs and descriptions of the major greenhouse gasses and their impact. He notes the important role of the ocean in temporarily moderating the global temperature rise. The chapter concludes with a discussion of Arctic amplification which leads into Chapter 6, "Sea Ice Meltback Begins", a description of the changes in Arctic sea ice since the nineteenth century. Peter includes several personal anecdotes from his field research, many of which have Canadian connections. He recalls flying on the DC-4 ice reconnaissance aircraft of the Atmospheric Environment Service (as the Meteorological Service of Canada was known) complete with mention of the infamous Flyers' Club in Gander. Peter recounts recognizing the thinning of the Arctic ice during his voyages on Royal Navy submarines (including the tragic 2007 voyage of HMS *Tireless*). He concludes the chapter with an account of his study of wave-ice interaction aboard the University of Alaska icebreaker *Sikuliaq* in the Beaufort Sea in 2015.

Chapter 7, "The Future of Arctic Sea Ice – The Death Spiral", is where Peter introduces his main thesis for the remainder of the book – that we have entered a climate regime where the heating of the Earth is not stoppable without drastic human intervention. He takes square aim at the Intergovernmental Panel on Climate Change for failing, in its 5th Assessment Report, to present the true state of Arctic sea ice and downplaying the threat by including an unrealistic climate projection.

In Chapter 8, Peter further supports his thesis by describing the numerous feedback mechanisms and shows how the Arctic sea ice retreat is not just a response but is also a driver of climate change. Chapter 9 expounds on the role of methane as a greenhouse gas and the potential impact of melting permafrost, which he calls a "catastrophe in the making".

Chapter 10, "Strange Weather", suggests the link between changes in the Arctic and weather extremes at temperate latitudes with consequences for food production and water supply. Chapter 11 describes the global ocean circulation and the critical role that sea ice plays in convection in the Greenland Sea. He laments the fact that, while "everyone accepts that the thermohaline circulation is a vital part of our climate system", there has been little support for research to better understand it.

¹ Retired from Canadian Ice Service, Environment Canada

Book Review

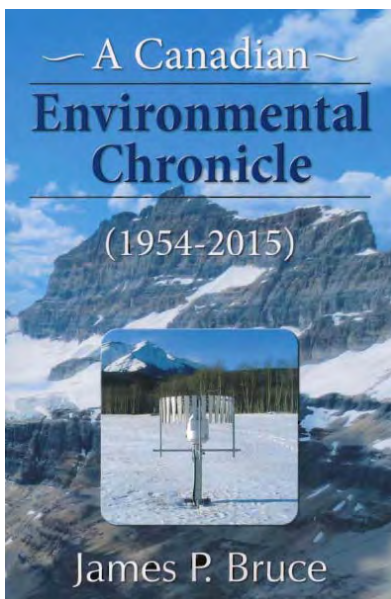
In Chapter 12, Peter changes poles to explain why the Antarctic is different from the Arctic. He recalls his voyages to the Weddell Sea aboard FS *Polarstern* in describing the physical differences in the ice and the annual cycle of the Antarctic sea ice. He cites well-known researchers to provide plausible reasons for why the Antarctic sea ice appears to be increasing in extent while the Arctic is reducing so rapidly.

After building a formidable argument linking changes in the Arctic to global climate and anthropogenic forcing, Peter presents a rather gloomy outlook in Chapter 13, "The State of the Planet". He contends that even radical reduction of greenhouse gas emissions cannot alter the disastrous course that has been set. Peter pulls no punches in his criticism of politicians for failing to show leadership. Even Greenpeace and the World Wildlife Foundation are criticized because of their opposition to nuclear energy and geoengineering.

Peter discusses several approaches to global scale geoengineering including cloud brightening to reduce the absorption of solar radiation. However, he feels that the only way the targets of the 2015 Paris Agreement can be reached is by direct removal of CO₂ from the atmosphere. He implores the world to mount a massive research programme to develop the necessary technology – while using geoengineering to buy the time needed.

In the final chapter, "A Call to Arms", Peter doubles down on his theme that "it is not enough to reduce carbon emissions". He calls for better science to improve the forecasts of climate change impacts while decrying the potential for war and the "black tide of denial", devoting several pages to rail against those in power who try to dismiss the threat of climate change. He wraps it all up in "A Time for Battle" by giving an itemized account of what individuals and society must do to avert the impending doom.

A Farewell to Ice is a compelling read. There is enough hard science to satisfy experts without intimidating the laity. There are well over a hundred references to scientific literature. Personal anecdotes from Peter's long career are scattered throughout to lend a sense of reality to the science. Many readers will not welcome his message but he presents it in a well-written, scientifically substantiated manner. It should be required reading for all world leaders.



A Canadian Environmental Chronicle (1954-2015)*

by James P. Bruce

Canadian Water Resources Association, ISBN 978-1-896513-39-3
2016, 131 pages

Book reviewed by John Stone¹

**Available from the Canadian Water Resources Association*

The author of this slim monograph, Jim Bruce, will be well known to members of the Canadian Meteorological and Oceanographic Society (CMOS) whether it be through Environment Canada where he was Assistant Deputy Minister (ADM) for the Environmental Management Service and the Atmospheric Environment Service; through the World Meteorological Organization where he was Acting Deputy Secretary-General and lead the creation of the Intergovernmental Panel on Climate Change (IPCC); or from his founding of the Canada Centre for Inland Waters and his life-long concern for water quality and quantity in Canada.

The book is as much an autobiography as a history of the many environmental issues that threatened Canada and the planet and with which the author has been deeply involved. It is a story of hope and disappointment, of progress and retreat, of scientific advances and policy inaction. The book was to have concluded with disappointment and a chapter entitled "Reflections: Environment in Decline". That was until 2015 which brought about a new progressive and environmentally sensitive government in Canada and the agreement of governments in Paris to a global action plan to address climate change. Hence a cautious Postscript: "A More Positive Future?".

¹ Adjunct Professor in the Department of Geography and Environmental Studies at Carleton University, Canada

Book Review

The book's chapters each deal with one of the environmental issues: Canadian Great Lakes water quality and Jim's involvement with the creation and running of the Canada Centre for Inland Waters; the long-range transport of airborne pollutants including the remarkable success in dealing with acid rain despite the intractable position of the United States; and ozone layer depletion and the establishment of the global response through the Montreal Protocol. The issue of climate change permeates the book; indeed it is the subject of the book's longest chapter.

Jim's involvement in these issues has been extensive and it is useful that the book provides a table with a chronology of his career and the awards he has received – and I'm sure there are many that are missing such as his important contribution to the establishment of the START program for the funding of global change research in developing countries. Indeed the author is extraordinarily modest regarding his contributions and goes to great length to mention many of his collaborators over the years including many CMOS members. He also gives due recognition to his wife who has quietly supported his work and accompanied him on his seemingly never-ending travels.

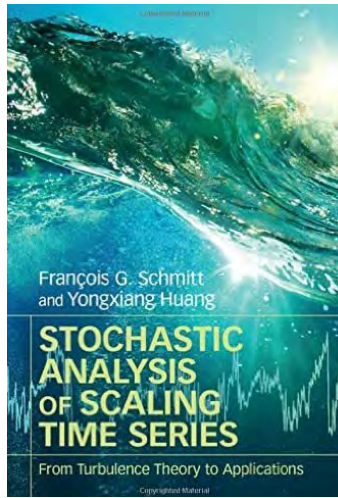
Jim provides examples of how decisions are made. One example is the move of Environment Canada's climate modelling group to Victoria. The Canadian Climate Centre was created within the Atmospheric Environment Service (now the Meteorological Service of Canada) in 1979, following the First World Climate Conference, by the then ADM Art Collin. Within the Centre was a small group of extraordinarily talented scientists, lead by George Boer, who were determined to develop a Canadian climate model. The model was based on the Environment Canada weather model. This model at the time did not include an ocean component. To fill this lacuna George Boer approached Jim Bruce with the proposal to transfer the modelling group to the West Coast where there were several groups with ocean modelling expertise. After some questioning of motives Jim gave his approval.

However, Jim shortly afterwards left for Geneva and nothing was done until the federal Green Plan provided a significant boost in the funding of climate science. At this time Kirk Dawson had replaced Howard Ferguson as head of the Canadian Climate Centre and I had been appointed Director of climate research. George Boer then approached me with the idea of moving his group out West. I took the proposal to the AES Management Committee (who were then coincidentally meeting in Vancouver) and the new ADM, Liz Dowdeswell. The University of Victoria was keen on hosting the climate modelling group and offered a spacious facility with free heat, light and power – an arrangement later provided for by the Provincial government.

The author also provides some light on how climate policy has been developed in Canada. An example is the development of Canada's negotiating position before and during the Kyoto Conference of the Parties under the UN Framework Convention on Climate Change. Prior to the negotiations there had been an extensive round of discussions with the Provinces. The consensus was that Canada would promise to return emission to 1990 levels by 2010. During the negotiations the United States, with the aid of a negotiations gaming program offered to reduce emissions by -7%. This made Canada's 0% reduction target look weak.

In the middle of the negotiations the Canadian Head of Delegation, Paul Heinbecker, called the Prime Minister's Office to report on progress. Jean Chrétien did not want to see Canada so much out of line with the US and unilaterally dictated a target of -6% much to the chagrin of the Provinces. Just how to meet this target was far from clear but it included the use of forestry and agricultural carbon sinks (something which was scientifically questionable) and the export of clean energy (such as hydro-power and natural gas) to reduce emissions elsewhere with Canada taking the credit. To work out the details a series of sectoral round tables were established which, according to Jim Bruce, was "an expensive bureaucratic exercise... that achieved very little". And then came the Harper government and Canada's withdrawal from the Kyoto Protocol

This book illustrates the importance of having the right person in the right place at the right time. It also shows the importance of a strong enabling environment lead by the federal government in the context of cooperative federalism – the environment knows no political boundaries. Let's hope a copy of this book lands on the desk of the Minister of Environment and Climate Change.



Stochastic Analysis of Scaling Time Series From Turbulence Theory to Applications

Par François G. Schmitt and Yongxiang Huang
Cambridge University Press, 2016, ISBN 978-1-107-06761-5, 203 pp.

Revue par André April¹

L'étude des fluides en géophysique est un domaine particulier, dans le sens qu'il est difficile de trouver des théories solides et adéquates. Les équations de Navier-Stokes sont non-linéaires, et la turbulence appartient au dernier champ de la physique classique toujours non-résolu. Plusieurs modèles fondés sur des approximations de la dynamique de ces équations sont imprécis et ne réussissent pas à capter la nature réelle, non-linéaire et intermittente de la turbulence. De nouvelles théories et modèles sont nécessaires. Une solution peut résider dans la généralisation et la continuation des travaux de Kolmogorov (1941) qui utilisent une loi d'échelle (scaling law) pour décrire les fluctuations des vitesses à différentes échelles.

Il existe plusieurs approches pour solutionner la nature turbulente d'un fluide. L'approche mathématique avec une solution complète n'a pas encore été résolue à ce jour. L'approche numérique pour résoudre les équations de Navier-Stokes utilise une discrétisation dans le temps et l'espace. La maille nécessaire doit être beaucoup plus petite que l'échelle de Kolmogorov (échelle visqueuse) et nécessite au départ une condition initiale à grande échelle. Des simulations partielles ont permis, jusqu'ici, de comprendre plusieurs propriétés de la turbulence. Par contre, des contraintes computationnelles font pour l'instant, que la solution envisageable pour des situations environnementales telles l'atmosphère et l'océan ne sera disponible qu'en 2030 ou 2050, si la puissance des ordinateurs continue sa croissance exponentielle. Enfin, l'approche phénoménologique, qui poursuit dans la voie tracée par Kolmogorov, consiste à regarder la solution stochastique des équations de Navier-Stokes en utilisant des propriétés expérimentales et la symétrie des équations. L'idée est de modéliser la nature intermittente de chaque solution, en utilisant des modèles stochastiques construits pour reproduire ces propriétés expérimentales. Rien ne prouve que ces solutions intermittentes représentent une solution mathématique des équations d'origine. Ces solutions sont souvent unidimensionnelles. Cependant, on y retrouve une propriété fondamentale de la turbulence, soit le phénomène d'intermittence. En outre, les auteurs utilisent des modèles multi fractales, pour la continuation de ces travaux. Des modèles multi fractales ont notamment été utilisés dans les domaines de la finance et de l'écologie terrestre et marine. Le concept multi fractale réside dans la considération de champs multi fractales comme étant une hiérarchie infinie d'ensembles, décrite seulement par trois indices, chaque ensemble possédant sa dimension fractale (Mandelbrot) propre.

L'objectif des premiers chapitres de ce volume est de décrire les développements historiques sur les lois d'échelle et multi échelle issues dans le champ de la turbulence et le transport de scalaire passif turbulent et la représentation de cascades d'énergie de la grande échelle aux plus petites. La turbulence est inhomogène et un processus dépendant des échelles en considération. Par la suite, les auteurs effectuent un survol des différentes lois d'échelle, incluant leur propre méthode et résultat. En 1998, Huang et al. ont développé une méthode nommée Hilbert-Huang Transform pour résoudre les signaux non-stationnaires, non-linéaires ou multi échelle dans le cas où ils coexistent simultanément. Cette méthode est composée d'un mode de décomposition empirique qui décompose une série temporelle en modes intrinsèques, suivis d'une analyse spectrale d'Hilbert qui associe à chaque mode une fréquence correspondante. Cette méthode est déjà utilisée dans plusieurs champs de recherche et d'application en génie. Après cette présentation méthodologique, les chapitres suivants utilisent des données expérimentales provenant de différents écoulements turbulents analysés comme étant des processus multi fractales, tel que la vitesse et la température Eulérienne provenant d'une soufflerie à grand nombre de Reynolds, la vitesse Lagrangienne d'un modèle numérique à haute résolution, la température provenant d'une cellule convective de type Rayleigh-Bénard et enfin, un champ de tourbillon provenant d'un modèle numérique 2D à haute résolution. Finalement, pour terminer le volume, on considère des études de cas de la variabilité stochastique dans le domaine de l'atmosphère et l'océan, tel que la turbulence côtière, le niveau et la qualité des eaux, la vitesse et la puissance des vents.

Ce livre intéressera principalement ceux qui ont comme sujet d'étude la description de l'analyse des données stochastiques de la turbulence. Les études de cas dans le domaine de l'océan et de l'atmosphère sont non-exhaustives. Heureusement, la plus part des études de cas dans ces domaines sont disponibles sur le web et citées dans les références à la fin du volume. On trouvera dans les références celle de Lovejoy et Schertzer (*The weather and climate: emergent laws and multifractal cascades*) qui pourrait être considérée comme un supplément à la lecture de ce livre. Notons ici qu'on n'exploite aucunement la structure multi fractale dans le but d'en faire une prédiction, ce qui aurait pu être intéressant et utile pour plusieurs lecteurs.

¹ Service canadien des glaces, Ottawa

In Memoriam: Matthew J. Parker

AMS Release: AMS MOURNS THE LOSS OF ITS PRESIDENT

MARCH 17, 2017 - BOSTON, MA - It is with great sadness that the American Meteorological Society announces the passing of AMS President Matthew J. Parker, CCM, who died in his sleep Wednesday night.



Parker, 53, worked at Savannah River National Laboratory in Aiken, South Carolina since 1989, most recently as Senior Fellow Meteorologist in the Atmospheric Technologies Group. He was elected as AMS President-elect in November 2015, and assumed the role of AMS President during the Society's Annual Meeting in Seattle this past January. Parker was slated to oversee the Annual Meeting in January 2018 in Austin.

"This is an enormous loss not just for the AMS family but for the entire scientific community," said Keith Seitter, AMS Executive Director. "Matt was deeply admired for his commitment to the AMS community. He was a leader and a friend, and we will all miss him tremendously."

According to the AMS Constitution, the current President-elect, Dr. Roger Wakimoto, assumes the authorities and responsibilities of president for the remainder of Parker's term. AMS will provide updates as we have them.

The Matthew J. Parker Travel Fund

In honor and remembrance of AMS President Matthew J. Parker, the AMS Council and its Executive Committee have established The Matthew J. Parker Travel Fund. Matt's greatest enthusiasm was directed toward students and early career professionals. He was always eager to share his experiences and provide guidance where he could, as well as doing all he could to provide opportunities to engage young members of the community in AMS activities so that they would have the best start possible for their career. In that spirit, the fund will provide travel grants to AMS meetings.

Donations to the fund can be made by mail, phone, or online at <https://www.ametsoc.org/ams/index.cfm/ams-giving-program/>

Checks should be made out to AMS and sent to:
The Matthew J. Parker Fund
American Meteorological Society
45 Beacon Street
Boston, MA 02108

If you have any questions, or wish to donate by phone, please contact 617-226-3906.

[Source: www.ametsoc.org]

Other CMOS News

Books in search of a Reviewer*:

(2015-4) *Thermodynamics, Kinetics, and Microphysics of Clouds*, 2015. By Vitaly I. Khvorostyanov and Judith A. Curry, Cambridge University Press, ISBN 978-1-107-01603-3, Hardback, 782 pages, \$108.95.

(2016-2) *Heliophysics: Active Stars, their Astrospheres, and Impacts on Planetary Environments*, 2016. Edited by Carolus J. Schrijver, Frances Bagenal, and Jan J. Sojka, Cambridge University Press, ISBN 978-1-107-09047-7, Hardback, 406 pages, \$68.95

(2016-5) *Convenient Mistruths: A novel of Intrigue, Danger and Global Warming*, by Geoff Strong, 2016. Published by Geoff Strong, ISBN 978-0-9952883-0-0, Paperback, 246 pages, \$19.99

(2017-1) *Weather: A Very Short Introduction*, 2017. By Storm Dunlop, Oxford University Press, ISBN 978-0-19-957131-4, Paperback, 152 pages, \$11.95

(2017-2) *Nonlinear and Stochastic Climate Dynamics*, 2017. Edited by Christian L.E. Franzke and Terence J. O'Kane, Cambridge University Press, ISBN 978-1-107-11814-0, Hardback, 468 pages, \$177.95

***You review it, yours to keep!**

Atmosphere-Ocean 55-2 Paper Order

Applied Research / Recherche appliquée

Evaluating the Ability of CRCM5 to Simulate Mixed Precipitation

É. Bresson, R. Laprise, D. Paquin, J.M. Thériault, and R. de Elía

Fundamental Research / Recherche fondamentale

Long-Term Rainfall Variability in the Eastern Gangetic Plain in Relation to Global Temperature Change

Aradhana Yaduvanshi and Ashwini Ranade

Interdecadal Variability of the ENSO–North Pacific Atmospheric Circulation in Winter

Peng Zhang, Zhiwei Wu, and Hua Chen

Biogenic Emissions and Nocturnal Ozone Depletion Events at the Amphitrite Point Observatory on Vancouver Island

T. W. Tokarek, D. K. Brownsey, N. Jordan, N. M. Garner, C. Z. Ye, F. V. Assad, A. Peace, C. L. Schiller, R. H. Mason, R. Vingarzan, and H. D. Osthoff



CANADIAN OCEAN SCIENCE NEWSLETTER LE BULLETIN CANADIEN DES SCIENCES DE L'OCÉAN

The Canadian Ocean Science Newsletter (COSN/BCSO) is published electronically every two months by the Canadian National Committee for the Scientific Committee for Ocean Research (CNC-SCOR). It is distributed via an email mailing list. It includes brief summaries of Canadian ocean science projects, meetings, job and study opportunities, and other items of interest to the Canadian oceanographic community. Recent highlights include a glider based study looking for whales and whale habitat in the waters west of Vancouver Island, modelling support for aquaculture, the changing carbonic chemistry of the Arctic Ocean, enhanced mixing rates in the Arctic Ocean and an open data repository to improve the public accessibility to ocean biogeographic data.

The Newsletter is always looking for brief summaries of current work, meeting announcements, and job and study opportunities. Please send contributions to David Greenberg, editor COSN/BCSO david.greenberg@dfo-mpo.gc.ca. Check the appropriate publication date so deadlines for abstracts, registration and applications are still workable.

To subscribe to this newsletter, please send an email to listserv@lists.mcgill.ca with the following message: SUBSCRIBE OCEAN-NEWSLETTER . Previous newsletters may be found on the [CNC/SCOR](http://cncscor.ca) web site.

Ocean articles, news and more in the March issue of the Canadian Ocean Sciences Newsletter (see <http://cncscor.ca/site/canadianprogram/newsletter>), including:

“Using ocean gliders to define whale habitat use of offshore waters of west coast Vancouver Island” by Rianna Burnham

Council / Conseil d'administration

President / Président

Martin Taillefer

Maritime Way Scientific Ltd., Ottawa, ON

Tel.: 613-841-0505; Cel.: 613-252-8311; E-mail/Courriel: president@cmos.ca

Vice-President / Vice-président

Wayne Richardson

Tel.: 613-729-6757; Cel.: 613-851-7071; E-mail/Courriel: vice-president@cmos.ca

Past-President / Présidente Sortante

Martha Anderson

Department of National Defence / D Met Oc, Ottawa, ON

Tel.: 613-996-3648; Fax.: 613-995-4197; E-mail/Courriel: past-president@cmos.ca

Treasurer / Trésorier

Michael Crowe

Environment and Climate Change Canada, Gatineau, QC

Tel.: 819-938-4379; E-mail/Courriel: treasurer@cmos.ca

Corresponding Secretary / Secrétaire-correspondante

Fiona Robertson

E-mail/Courriel: corsec@cmos.ca

Recording Secretary / Secrétaire d'assemblée

Marie-France Gauthier

Tél.: 613-668-3927; E-mail/Courriel: recsec@cmos.ca

Councillors-at-large / Conseillers

1) Patrick Roussel

Metocean Services, Dartmouth, NS

Tel.: 902-468-2848; E-mail/Courriel: patrick.roussel@amecfw.com

2) Robert Sica

University of Western Ontario, London, ON

Tel.: 519-661-3521; E-mail/Courriel: bobsica@purplecrowlidar.ca

3) Nadja Steiner

Department of Fisheries and Oceans, CCCma, Environment Canada

E-mail/Courriel: nadja.steiner@canada.ca

Next Issue of the CMOS Bulletin SCMO

The next issue of the CMOS Bulletin SCMO will be published in June 2017. Please send your articles, notes, workshop reports or news items before May 6th, 2017, to bulletin@cmos.ca.

This publication is produced under the authority of the Canadian Meteorological and Oceanographic Society. Except where explicitly stated, opinions expressed in this publication are those of the authors and are not necessarily endorsed by the Society.

Prochain numéro du CMOS Bulletin SCMO

Le prochain numéro du CMOS Bulletin SCMO paraîtra en juin 2017. Prière de nous faire parvenir avant le 6 mai 2017 vos articles, notes, rapports d'atelier ou nouvelles à bulletin@cmos.ca.

Cette publication est produite sous la responsabilité de la Société canadienne de météorologie et d'océanographie. À moins d'avis contraire, les opinions exprimées sont celles des auteurs et ne reflètent pas nécessairement celles de la Société.

Thank you to Bob Jones and Paul-André Bolduc, for their continued editorial assistance and guidance.

*Printed in Ottawa, Ontario, by St. Joseph Print Group Inc.
Imprimé par St. Joseph Print Group Inc., Ottawa, Ontario.*

51st CMOS Congress

51^e Congrès de la SCMO

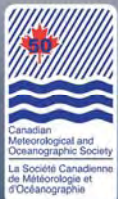


Future Earth

Weather, Oceans, Climate

La Terre de l'avenir

Météo, océans, climat



June 4 - 8th | 4 au 8 juin

2017 TORONTO

Hilton Toronto Downtown | Hilton Toronto, centre-ville

Art & Design: Alicja Parlak, Toronto, ON

WATER.

It's in our nature.

Watershed management advisors make crucial decisions based on snow and water data. When spring arrives, deciding when to open or close sluice gates could mean the difference between a flood and responsible resource management during a drought. Campbell Scientific has been providing real-time, automatic snow and water monitoring systems in Canada for over 35 years and we understand the challenges of measuring these resources. When you need reliable, accurate data, you can rely on our systems and the expertise of our Measurement Consultants. **We'll help you make the best possible measurements, so you can make the best possible decisions.**

 **CAMPBELL
SCIENTIFIC**
WHEN MEASUREMENTS MATTER
campbellsci.ca | 780.454.2505